

Standard Version



Enclosed Version



The Do it Yourself Cockpit Project – Series One

Table of Contents

Introduction.....	3
Chapter One - Tools.....	5
Chapter Two - Bill of Materials.....	9
Chapter Three - Cockpit Components.....	13
Chapter Four - Constructing the Center Base.....	19
Chapter Five - Constructing the Sides.....	31
Chapter Six - The Forward Turtle Deck & Instrument Panel Arch.....	49
Chapter Seven - The Aft Cockpit Arch.....	61
Chapter Eight - Skinning the Cockpit Sides.....	65
Chapter Nine - Skinning the Forward Turtle Deck and Instrument Panel Support Arch. .	73
Chapter Ten - Skinning the Aft Cockpit Arch.....	79
Chapter Eleven - Finishing and Installing the End Caps.....	83
Chapter Twelve - Assembling the Cockpit.....	91
Chapter Thirteen - Building the Monitor Support Deck.....	103
Chapter Fourteen - Building the Windscreen.....	113
Chapter Fifteen – Building the Canopy.....	153
Chapter Sixteen – Final Assembly & Finishing Tips.....	167
Appendix A – Reference Drawings.....	185

The Do it Yourself Cockpit Project – Series One

Introduction

First of all I'd like to thank you for your interest in this DIY Cockpit Project. I hope you get as much enjoyment out of building and simming in it as I did designing and building it myself.

This first project is optimistically called the "Series One" cockpit. It's my hope that there will more DIY Cockpit designs to cover other general types of aircraft.

As a first endeavor, I look forward to getting feedback from you and your fellow builders. There is a mailing list set up for your use at the following address:

<http://www.simpits.org/mailman/listinfo/diy-cockpit>

There is also a web-based forum available at <http://www.simpits.org/forum>. See the message board called "Gene's DIY Cockpits". Please note that the mailing list and the web forum are completely separate and don't share content. If you post a question in one place, it won't appear in the other.

I encourage participation in the mailing list and the forum as input or modifications from your fellow builders have the potential to make a good design even better.

One thing I've learned during the construction of this project is that nothing is 100% perfect. You'll run into things like the seams won't mate completely, etc. I've done my best to make sure that all the parts fit and things line up, but remember, we're working with wood. There will be differences between what I show and what you end up with. It's not the end of the world. ☺ Wood putty and paint can hide any number of sins. Don't worry about it.

If you have any questions or problems, please don't hesitate to send me an email – my address is geneb@deltasoft.com.

I'd like to thank Robbi Hommel for being a great sounding board, even if he didn't know what I was up to most of the time. ☺

I'd also like to thank David Allen for putting up with my stupid Inventor questions until I finally got a grip on what I was doing.

To all on the Simpits-Tech list at simpits.org, thanks for putting up with my constant harping about this project! You guys are the best!

On to the good stuff....

The Do it Yourself Cockpit Project – Series One

The Do it Yourself Cockpit Project – Series One

Chapter One - Tools...



This is a ShopBot. There are many like it, but this one is mine.

The Do it Yourself Cockpit Project – Series One

Here's a list of some basic tools that you're going to need in order to build this project. They're in no real order and frankly, they occur as I think of them. ☺

1. A Jig saw with suitable blades for cutting MDF or OSB, depending on what your material of choice is going to be for the cockpit. Pawn shops are a good place to find these – especially the heavy duty (physically pretty heavy as well) ones. The heavier the Jig Saw, the better cut you'll get out of it. The weight helps counteract the reciprocating action of the blade and reduces the tendency of the saw to “jump”.
2. A good electric screw driver. You will go out of your mind if you try driving all the needed screws by hand. Trust me on this. Two models I use are the Ryobi Lithium 4V driver (Model # HP41L) and the Skil iXo² Lithium Ion driver. Both are good tools and get the job done. Make sure you've got the regular PH2 Phillips tip as well as the larger PH3 tip. The PH3 tip is used in the ¼”x20 flat head screws that are used to attach the end caps. A PH2 is too small to drive them “properly”.
3. A set of good drill bits. Since you're not going to be doing any serious metal drilling (at least for the parts I'm showing you), any cheap set will get the job done. Most of the holes you're going to be drilling are ¼” for bolt holes and 5/16” holes for the places where you'll use the ¼” T-Nuts. You'll also be drilling quite a few 7/64” pilot holes for #8 screws. This of course leads to...
4. A good drill. I prefer a battery powered one – I get more flexibility out of it and no cord to get in the way. I personally use a Makita 9.6v as well as a Black & Decker 18v Fire Storm. Pretty much any good drill will serve your needs though.
5. A 7/16” socket wrench. All the ¼”-20 hex head bolts need this size.
6. A device called a “Micro Stop”. This is an aircraft metalworking tool that is used to create countersinks for flat head rivets. In this project it's used to countersink in wood for screw heads. You can't swing a bat without hitting a pile of these things on eBay. They're pretty inexpensive and you can get the two bits you need on line from Aircraft Spruce. The two cutters you'll need are the ¼” and #8 screw cutters. (Aircraft Spruce Part #s 12-00881 and 12-00947 respectively)



Here is an example of a typical Micro-Stop

The reason I specify these is that by using a Micro-Stop, you can control the depth of the countersink and that's very important, especially if you're a novice woodworker. The cutters are 100 degree while all the fasteners we'll be using are 82 degree, but it works out just fine.

The Do it Yourself Cockpit Project – Series One

7. A circular saw. Any 7-1/2” circular saw will work. If you don’t have one already, check out the local pawn shops. You can usually get a good deal on a high quality saw that way. (Rob has gotten *steal* on a magnesium chassis worm drive saw that way.)

8. A table saw. You knew this was coming, didn’t you? ☺ Seriously, a table saw is literally required (unless you’re some kind of god with a circular saw) in order to make the canopy and windscreen frame options. Unfortunately, this doesn’t mean a table-top table saw. They don’t have the depth of throat required to accommodate the windscreen and canopy frame parts that need to have angles cut in them. However, this is a GREAT excuse to get that full sized table saw you always wanted, right? ☺ Again, hit the pawn shops – you’d be surprised what you can find there.

9. A Wixey Digital Angle Gauge. If you’re going to make the windscreen and canopy for your cockpit, you MUST be able to set the blade angle of the table saw to 23.5 degrees. This is the best way I’ve found to do this. This little thing paid for itself the first time I used it. This is an item that Rockler sells – <http://www.rockler.com> is the address of their site. Be warned though, therein lies Much Tool Porn. You’ve been warned. ☺

10. Self-Centering pilot drills. These little gadgets come in really handy when installing hinges or brackets that have pre-drilled holes. Nothing makes a person madder than getting the pilot hole just a bit off center and having the screw ruin the alignment of what you’re working on. This is a nice to have – again, they’re available at Rockler or pretty much any other fine vendor of woodworker Tool Porn.

11. A router. If you’ve purchased the router templates, you’re going to need a good router and a router table. You’ll also need a 1/4” flush trim bit with a 1/4” shank. This bit is unusual because the bearing is also 1/4”, which is required in order to navigate the interior slot cuts on the templates. MLCS Woodworking sells these - \$9.50 for the 1” version (MLCS P/N 5499). This cutter or one exactly like it is required in order to use the router templates. Any bit with a bearing size of greater than 1/4” won’t fit.

12. A good Combination Square. You’ll use this to draw centerlines along parts. It’s a pretty slick technique for those that haven’t done it before.



Combination Square

The Do it Yourself Cockpit Project – Series One

13. Last but not least, you are probably going to want to get yourself a Pin Nailer. This is an air-powered tool that you can use to tack together assemblies as well as attach the skin. The model that places like Harbor Freight Tools carry is pretty basic and will only set you back about \$30, not including the air compressor you'll need. Check out the local pawn shop for a good second hand compressor. The smaller "pancake" style will be perfectly adequate for the nailer.

14. A small mallet that has a two sided head – one side is made of rubber; the other is made of a hard plastic. This will come in handy when you're installing the ribs.

Please note that power tools will do their very best to at least maim you the instant that you stop paying attention. Always pay attention to the warnings given about the tools you're using and always and I mean **ALWAYS** wear safety glasses!

Chapter Two - Bill of Materials

...or “Oh my god, what have I gotten myself into?”

The Do it Yourself Cockpit Project – Series One

Here's a list of the basic materials you'll need in order to create the parts needed for your cockpit. Note that I will refer to both OSB (Oriented Strand Board) and MDF (Medium Density Fiberboard) interchangeably throughout these instructions. The plans were created so that you could use either or both of those primary materials for the cockpit, depending on your budget. Note that quantities listed for the specified fasteners are not cast in stone. I have used more or less during the actual build for this manual. The only count cast in stone is the quantity of 1" 1/4-20 flat head screws.

1. ___ 6 4'x8' sheets of either 1/2" MDF or 7/16" OSB. If you're really careful, you can get by with 5 sheets by carefully optimizing the material use. The last sheet is used for the center section and the remainder of that sheet is ripped down into stringers.
2. ___ 2 4'x8' sheets of 1/8" Tempered Hardboard. This is used for the skins as well as the instrument panel.
3. ___ 90 1/4"-20 T-Nuts. Yes, **90** of them. They're used throughout the cockpit in order to help make assembly (and disassembly!) much easier. I strongly suggest you buy these in bulk if you can. You can buy a box of 100 from BoltDepot.com for about \$7.
4. ___ 7 or 11 #8-32 Threaded Inserts. These are used when you mount the instrument panel. If you're building the windscreen option, you'll need 7 for the panel, if you're not building the windscreen; the other panel requires 11 inserts to mount. Note that for the windscreen instrument panel, you can use either the threaded inserts for #8 screws or t-nuts threaded for #10 screws. The inserts are similar to the picture below.



These are the ones I use, McFeely's P/N is 3603-STS-D.

5. ___ 53 1/4"-20, 1" Flat Head Screws. These are used to attach the end caps and the upper section caps.
6. ___ 3 1/4"-20, 1-1/2" Flat Head Screws. These are used in the upper section caps.

The Do it Yourself Cockpit Project – Series One

7. ___ 6 2-1/2” wide hinges with removable pins. 4 of them are used on the end cap doors, 2 on the monitor deck if you’re building that. (only for the windscreen builders)
8. ___ 1 1-1/2” wide piano hinge. This is only for those building the canopy. I *strongly* recommend that you purchase one that you can easily remove the hinge pin from. Aircraft Spruce carries these in 36” lengths for about \$6. You can substitute 2 2-1/2” hinges if you like.
9. ___ 10 1/4”-20, 3.5” hex head bolts (5 on each side are used to mate the sides to the center section)
10. ___ 4 3” caster wheels. You can use larger wheels if you’ve got them, but I would recommend against using anything smaller. The larger wheel helps when moving the cockpit around and the extra height is handy if you decide to use the Jentron Gimbal (http://www.geneb.org/pitkit/jentron_mk2/).
11. ___ 16 1/4”-20, 1” hex head bolts (used for attaching the wheels to the center section).
12. ___ 26 1/4” flat washers. Used in various places.
13. ___ 1 box (minimum of 100) #8, 1-1/4” flat head wood screws. You’ll use these mostly to attach the decking to the 2x4 framing for the base of the cockpit. The windscreen also uses a number of these
14. ___ 1 small box of 1” #8 flat head wood screws. These are needed only for the windscreen.
15. ___ 1 small box or 3/4” #8 flat head wood screws. These are needed only for the windscreen.
16. ___ 5 2x4, 8’ long. These are used for framing the left, right and center sections. I should note that “2x4” in this case means a typical US “framing stud” which is actually 3-1/2” x 1-1/2”. (just in case those of you overseas find a real 2”x4” board)
17. ___ Scrap 3/4” Plywood – this will be used to build the two 5” x 23-7/8” caster supports for the main base. The 5” width can be fudged a bit if you can find yourself a 10” wide x 24” long scrap. You should be able to buy a small 24x24 sheet of 3/4” AC plywood at your local home center if you don’t have any scraps available.
18. ___ 8 1” #6 flat head screws. Used to hold the end ribs in place for the cockpit sides.

The Do it Yourself Cockpit Project – Series One

Chapter Three - Cockpit Components



The Do it Yourself Cockpit Project – Series One

There are 34 basic part shapes used to build the Series One cockpit, not including “stock” material like 2x4s and cut to size stringers. You may or may not use all the parts depending on the options you choose to build. Please refer to the reference drawings in Appendix A for part locations.

Here is an overview of each part and how many of each you’ll need.

Part #	Qty	Drawing Name	Description
1	12	Right cockpit side – narrow, left cockpit side - narrow	<p>Standard Rib. You’ll make 6 of these for each cockpit side. Note that the plan shows the #1 parts with holes in them. The holes that follow the outside perimeter shape of the rib are used to attach the end caps to the cockpit. If you use the recommended ¼-20 t-nuts, you should drill these holes at 5/16”, not the ¼” specified in the drawing. The outside barrel diameter of the t-nut is just a bit smaller than 5/16”.</p> <p>These holes are only to be drilled in the parts used at either end of the left and right sides. There’s no need to drill them in the other parts.</p> <p>If you’re not building the windscreen and canopy, you’ll need to drill out the three holes that follow the inner perimeter of the rib. These are mount points for the instrument panel. They do not need to be over-drilled as the barrel on the #10 t-nut will fit the specified ¼” diameter holes. Only the ribs in position #3 need to have these holes.</p>
2	10	Right cockpit side, left cockpit side	Cockpit Section Rib. You’ll need to make 5 of these for each side. These ribs support the cockpit rails.
3	2	Forward Turtle Deck	Forward turtle deck rib. The forward turtle deck is only constructed if you’re not building the windscreen option.
4	2	Forward Turtle Deck, Instrument Panel Support	Forward turtle deck rib, narrowed. This rib has holes in it to allow long instrument panel bolts to pass through it if needed. This part is also used in the Instrument Panel Support assembly.
4A	1	Instrument Panel Support	This is a “dress” rib. It acts as a “glare shield” support of sorts. Again, only built if you’re not building the windscreen option.

The Do it Yourself Cockpit Project – Series One

Part #	Qty	Drawing	Description
5	2	Aft Cockpit Arch, Squared & Rounded	Longeron for aft cockpit arch. This part is the same regardless of which version of the arch is built (Squared or Rounded). This part may be over-drilled to 5/16" in order to accept a 1/4"-20 t-nut if you want the mounting bolt to enter the part from underneath.
6	2	Right cockpit side – narrow, left cockpit side - narrow	Aft section longeron. This is the base part that Part #5 mates to. If you'd like to have the retaining bolts enter from #5, you can over-drill these to 5/16" in order to take a 1/4"-20 t-nut.
7	2	Lower End Cap - Narrow	End Cap Doubler. This part is required on the aft fuselage cap – it helps structurally bind the lower cap to the Aft Cockpit Arch end cap. The forward end cap doubler is not used if you're building the windscreen version OR you want to hinge the forward turtle deck assembly for easier interior access.
8	2	Forward Turtle Deck	Forward turtle deck base longeron. If you're going to bolt down the forward turtle deck to the forward fuselage, you only need to use one mounting hole at each end. More are provided if you feel you need them. If you're going to use 1/4"-20 t-nuts, the holes will need to be drilled to 5/16". The configuration of this assembly requires that you insert the t-nuts into this part as bolt head access from this side is nearly impossible after the skin has been applied.
9	2	Instrument Panel Support	Instrument Panel Support Longeron The mounting holes in this part should be drilled to 5/16" if you're going to use 1/4"-20 t-nuts to mount the assembly to the cockpit.
10	2	Right cockpit side – narrow, left cockpit side - narrow	Forward Section Longeron. This part is present in all versions of the cockpit. More mounting holes than necessary are provided. Please use the matching holes you'd chosen for use with Part #8.
11	4	Aft Cockpit Arch, Rounded	Aft Cockpit Arch, Rounded. This component is shown on the drawing as a "half" part, and in the parts illustration as a single unit. The half parts are joined during construction and 4 of these halves are required. This part is not used with the canopy feature as the rounding is not present in the canopy frame. The holes in these parts need to be drilled to 5/16" in order to accept t-nuts.

The Do it Yourself Cockpit Project – Series One

Part #	Qty	Drawing	Description
12	2	Right cockpit side – narrow, left cockpit side – narrow	Cockpit Side Base – Narrow. This is the component that each cockpit side is built upon.
13	1	Aft End Cap – Rounded - Narrow	Aft Cockpit Arch End Cap – Rounded. This part attaches to the rounded version of the aft cockpit arch assembly.
14	1		Aft Cockpit Arch Face Cap – Rounded. This part attaches to the front face of the rounded version of the cockpit arch assembly.
15	2	Windscreen	Instrument Panel Support Arch – Windscreen Only Of the two identical parts used, ¼” holes are only required in the “front” part as shown in the illustration. #10-24 t-nuts are installed in those holes.
16	1		Aft Cockpit Arch Face Cap – Squared. This part attaches to the front face of the squared version of the cockpit arch assembly.
17	1	Aft End Cap – Squared – Narrow	Aft Cockpit Arch End Cap – Squared. This part attaches to the back face of the squared version of the cockpit arch assembly as well as to the end cap mating plate that is in turn attached to the lower end cap.
18	2	Aft End Cap – Squared/Narrow	Lower End Cap – Narrow. These two parts form the fore and aft fuselage end caps.
19	2	Aft End Cap – Squared/Narrow	Lower End Cap Door. These are the access doors that should be installed in both the fore and aft end caps.
20	2	Windscreen	Left & Right windscreen side frames
21	1	Windscreen	Lower Face Frame This component makes up the forward area of the windscreen assembly.
22	1	Windscreen	Windscreen Top Frame
23	1		Standard Arch Instrument Panel
24	6	Windscreen	Windscreen Face Frame This component is shown on the drawing as a “half” part, and in the parts illustration as a single unit. The half parts are joined during construction and 6 of these halves are required. (2 for the windscreen, 4 for the canopy framing)

The Do it Yourself Cockpit Project – Series One

Part #	Qty	Drawing	Description
25	4	Aft Cockpit Arch – Squared	This component is shown on the drawing as a “half” part, and in the parts illustration as a single unit. The half parts are joined during construction and 4 of these halves are required. The holes in these parts need to be drilled to 5/16” in order to accept t-nuts.
26	1		High Arch Instrument Panel Used when installing the alternate instrument panel support arches (Part #31)
27	1		Standard Instrument Panel. This design is used when the windscreen/canopy option is not used.
28	4	Monitor Deck	Monitor Deck Longerons Only used with Windscreen option.
29	4	Monitor Deck	Monitor Deck Ribs
30	1	Monitor Deck	Monitor Deck Face
31	2		Alternate Instrument Panel Support Arches These are only used with the windscreen option and are the mating part to Part #26.
32	1		Forward turtle deck end cap. This part attaches to the Forward Turtle Deck Assembly.
33	1		Cockpit Center Section.
34	2	Right cockpit side – narrow, left cockpit side – narrow	Cockpit railing. This is an alternate part design for those that can cut angles in flat stock. Using this part will eliminate the requirement to build up the outer surface of the cockpit rail in order to support the fuselage skin.

The Do it Yourself Cockpit Project – Series One

The Do it Yourself Cockpit Project – Series One
Chapter Four - Constructing the Center Base



The Do it Yourself Cockpit Project – Series One

The first part to be built is the “center core”. All the sub-assemblies for the cockpit depend on this part being accurate, so please take your time!

For this assembly, you’re going to need the following materials:

Qty	Description
4	72” 2x4 – Used for left & right cockpit sides and the center core sides
1	72x24 ½” Cockpit Floor (7/16” OSB or ½” MDF)
2	21” 2x4 – Fore & Aft ends
42	#8 1-1/4” wood screws
22	#8 2-1/2” wood screws
16	1/4”-20 1” hex head bolts
16	¼” washers
16	¼-20 t-nuts
4	3” Caster wheels
1	¼” drill bit
1	5/16” drill bit
1	7/64” drill bit (used for pilot holes for #8 screws)
1	Micro-stop (or other countersink bit)

The first thing to do is take your four 72” 2x4s and clamp them together at the ends and then mark them like this:



This is done in order to make sure that when you drill the mounting holes for the side sections (the next step), the left and right side mounting holes will align perfectly. By drilling both parts at the same time you don’t have to worry about getting two identical hole layouts done on each part.

The Do it Yourself Cockpit Project – Series One

Leaving the parts clamped together, make a mark on the wide face of the top 2x4 at 36". Then measure 14-1/2" from that point and make another mark. Move another 14-1/2" down and make another mark. Do the same on the "other" side of the first 36" mark. You should have five equally spaced marks along the length of the 2x4 now.

Take your combination square and set it up so that only 1-3/4" is sticking past the flat edge of the square, like this:



You're then going to drag a pencil and the combination square along the top of the 2x4 in order to make a centerline along the whole board, like this:



The Do it Yourself Cockpit Project – Series One

Do this on both your paired 2x4s and then drill a 1/4" hole through both of the clamped 2x4s at the marked locations. After you've done this, change to a 5/16" drill bit and drill out the 1/4" holes that are in the parts marked "left side" and "right side". You'll install 1/4"-20 t-nuts into these holes later.

The base frame consists of two 72" 2x4s and 2 21" 2x4s. These parts are attached with the 8 2-1/2" wood screws listed above. Note that these screws are not meant to be structural. They're only there to hold the frame together until the cockpit floor is installed.

Clamp the ends of the framing together like this:

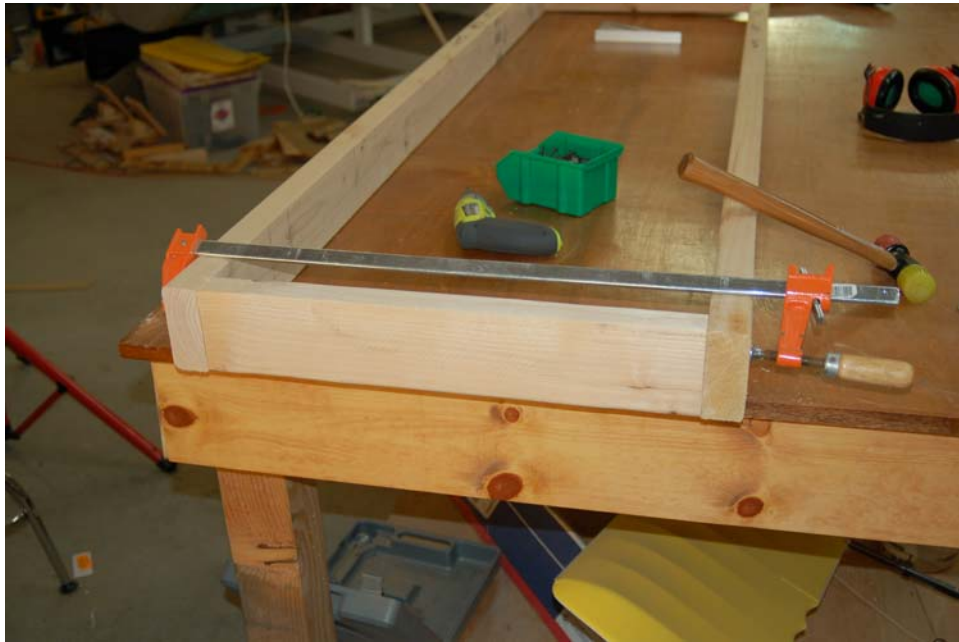

After clamping both ends together as shown above, verify that the corners are as square as you can make them – this is very important. Also, grab a tape measure and check to make sure that the width of the frame as measured from the outside surface of the 2x4s is 24". If it's not, you need to make sure that you've cut the shorter 2x4 part to exactly 21".

The Do it Yourself Cockpit Project – Series One

Now that you're all squared up, place two screws at each corner like this:



Before you mount the cockpit floor to the base frame, you should mark the sides of your 2x4s with the same markings you put on the top in the first step. What I'm talking about looks like this:



This is done to help you identify which side you're working on after the cockpit floor is installed.

The Do it Yourself Cockpit Project – Series One

Set your combination square to $\frac{3}{4}$ " and draw a line around the entire perimeter of the 72x24 cockpit floor section. If you start at the far end and walk backwards, it's a easier. Just hold the pencil tip to the center of the ruler in the combination square and slide the pencil and the square along at the same time.

You should end up with lines that look like these:



Measuring from where the lines intersect at the corner, I want you to put a mark every 4-1/2". These are your screw location marks. It's not perfect as the screw location from the last mark you make on the long edge to a corner won't be 4-1/2" from the corner line intersection, but that's okay. Do the same along the short edges. The short span will only have four marks on it.

Apply a bead of glue on the top of the base frame and set the cockpit floor on it. Drill $\frac{7}{64}$ " pilot holes in to corners along the long edge. You now need to make sure that the frame is square to the floor. A big help to getting the frame squared to the floor is to use clamps to "pull" it square. If you don't have a single clamp that can span 72" easily, you can "daisy-chain" clamps together to reach where you need to. This is what I had to do. ☺ (Thanks to Rob for this money saving idea.)

The Do it Yourself Cockpit Project – Series One

Here is a picture that shows an example of how the clamps “lock” together:



It looks like of silly, but in a pinch it'll get the job done. As you bring the frame square, drill a pilot hole in the corner, countersink it and throw a screw into it. This will help hold it. When you're sure you're all squared up, drill, countersink and install the screws along the short edge.

You may need to correct for any bow-out that the long 2x4s may have. In order to do this, you'll need a couple of 24" clamps set up like this:



The Do it Yourself Cockpit Project – Series One

If your 2x4s have a bow-in problem, you can correct it by sliding in some 21” lengths of 2x4 to the underside until you’ve got the long edges screwed down. Once you’re satisfied with whatever correction was needed, go ahead and drill all the pilot holes, countersink ‘em and drive in your screws. When you’re done, you should have something that looks like this:



Now it’s time to add the four casters to the base so you can move it around when it’s done!

In order to mount the casters, we need to cut a support plate that they’ll bolt to and that plate will in turn be attached to the bottom of the cockpit center frame.

Cut two 5” wide by 23-7/8” long strips of 3/4” AC plywood (the scrap mentioned at item #15 in the Bill of Materials list in Chapter Three). Set up your combination square for 1-3/4” and draw a line along the long edge of the wheel mounting plate as shown in the picture on the next page.

The Do it Yourself Cockpit Project – Series One

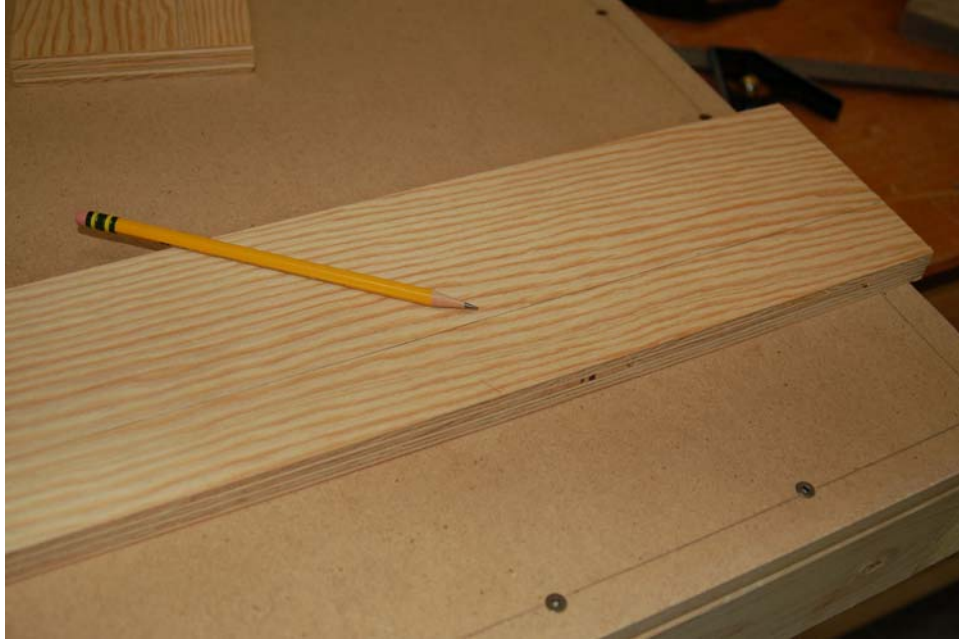

This line shows you where the “front” edge of the 2x4 will be when the plate is mounted to the cockpit floor. When you install your casters on this plate, you’ll want the long edge of the caster base to be even with this line, as shown below:



The short edge of the caster should be placed about 2” from the outside edge of the mounting plate. Mark and drill your hole centers with a smaller bit (1/4” will work fine) – you’re now going to over-drill them to 5/16” in order to install the 1/4-20 T-nuts on the underside of the mounting plate.

The Do it Yourself Cockpit Project – Series One

The simplest way to set the t-nuts into the wood is to do it at the same time you install the casters. Just hold the t-nut in the mounting hole and thread in the 1" 1/4-20 hex head bolt (and washer!) through the first mounting hole in the caster base plate. Repeat with the rest and as you tighten the bolts, the prongs will be drawn into the wood. You want the t-nut to be tightly flush against the wood; cutting into it a bit is okay too.



After you've got all four casters mounted on the two base plates, you need to mount those plates on to the bottom of the cockpit center section. Set your combination square for 3/4" and draw center lines along the short edges of the mounting plate and along the long edge that will be over the 2x4. Mark the side hole centers 3/4" from the edge of the board. Mark the 12" point along the long edge and to 6" on either side of that mark. Drill pilot holes and countersink. Each end takes 7 2-1/2" wood screws as shown below:



The Do it Yourself Cockpit Project – Series One

Next, you should expand the side holes to 5/16" and get the 10 t-nuts installed:



You now have a complete center section for your cockpit or the largest skateboard you've ever seen, guaranteed to do you grievous bodily injury the first time you take it outside. 😊

The Do it Yourself Cockpit Project – Series One

The Do it Yourself Cockpit Project – Series One
Chapter Five - Constructing the Sides

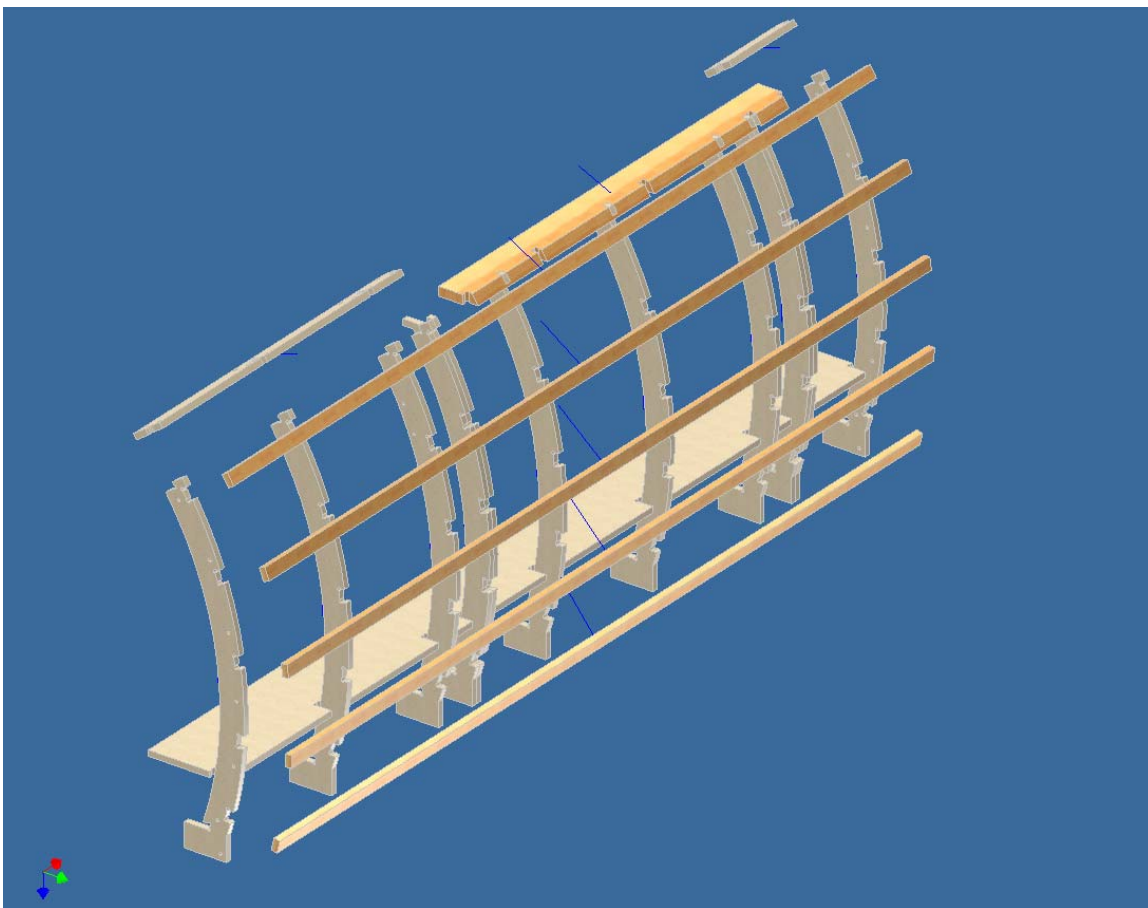

The Do it Yourself Cockpit Project – Series One

Now it's time to build the two side sections. They are built opposite of each other, so please take care to not make two left or two right sides!

For this assembly, you're going to need the following materials:

Qty	Description
2	72" 2x4 – Used for left & right cockpit side support frames
2	Part #12 – Cockpit side base plates
4	5" 2x4 – Used for the left & right cockpit side support frames
44	#8 1-1/4" wood screws
8	#8 2-1/2" wood screws
4	Part #1, standard rib with end cap mounting holes
6	Part #1, standard rib with no holes
10	Part #2, cockpit section ribs
2	Part #1, standard rib with instrument panel mounting holes
1	Part #34 – cockpit rail (left)
1	Part #34 – cockpit rail (right)
2	Part #10 – forward section longeron
2	Part #6 – aft section longeron
10	72" 1" x 1/2" stringers
1	7/64" drill bit (used for pilot holes for #8 screws)
1	Micro-stop (or other countersink bit)
1	Two face rubber mallet (one with rubber on one side and plastic on the other).

The first thing I need to talk about before we begin is the cockpit rails. The cockpit rails are made from 3/4" stock – you can use pine, MDF, plywood or whatever you've got handy that's 3/4" thick. The prototype used 3/4" pine and the one I'm building along with you uses the new rail design in MDF.

The old style rail in the prototype wasn't notched – the notches in the updated rails serve to both align the cockpit section rails and to avoid the extra filler material between the ribs that was required during the skinning phase of the prototype. The new design requires that you have a table saw and a good angle gauge.

If you don't have a table saw, you can still make the new rail design, but you'll need to narrow it down by 5/16" on the side with the notches on it. This will allow the rail to continue to act as a rib spacer and will also reduce the amount of "filler" you'll need to use before skinning the sides.

For the table saw users out there, you need to cut two angles in each cockpit rail – keep in mind that there IS a left and a right! If you're not careful you can easily end up with two parts for the same side.

The Do it Yourself Cockpit Project – Series One

The first angle you're going to cut is 33 degrees. Set up your table saw so your angle gauge (you *did* get a digital angle gauge, didn't you?) looks like this:



Now that you've got the saw blade set at the right angle, you need to to lower it until the highest point on the blade is $\frac{3}{4}$ " from the table surface:



The Do it Yourself Cockpit Project – Series One

This is done because the next step is to position the table saw fence exactly 2-15/16” from the highest point on the saw blade:



Once your fence is set, you can move the blade up just a little bit. For those that haven't done this before, in order to get the correct distance from the fence to the inside surface of the blade, you've got to get the blade set at the same height as the material you're cutting, otherwise the pitched angle of the blade will cause your distance measurement to be incorrect.

When you cut the left rail, position it into the saw with the two notches that are close together are the “start” point, like this:



The Do it Yourself Cockpit Project – Series One

The right side rail should be positioned so that the two notches are opposite of how you positioned it for the left side cut:

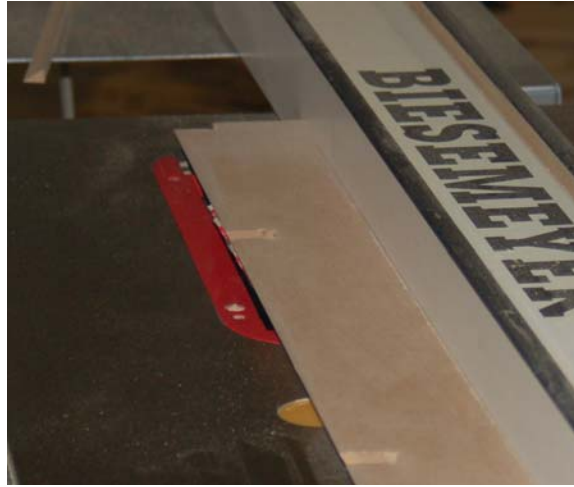

When you're done, you should have a pair that looks just like this:



Now you need to trim the rail down by about 1/8" or so. Set your table saw for 2-13/16". You're going to trim the "pointy" ends off of the rails in order to make the next (last, I promise!) bevel cut on the rail to finish its shape.

The Do it Yourself Cockpit Project – Series One

When you're done with the cut, it should look like this:

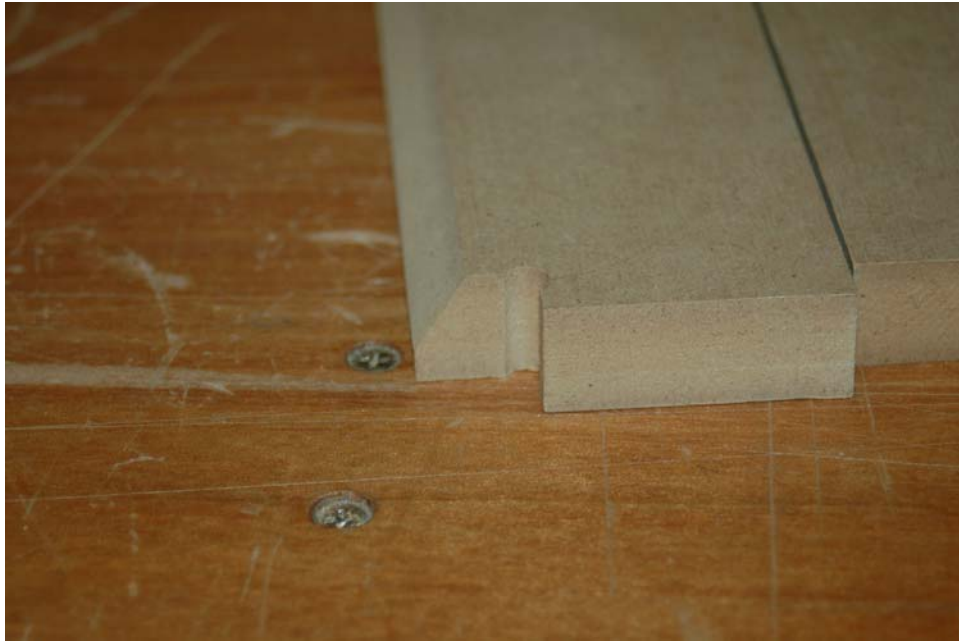

The next bevel cut is kind of tricky, so please take your time and be VERY, VERY careful! Table saws live and die by how much human blood they consume over their service life. You don't want to give them too much at one time. They'll be thirsty for more and may start to stalk you.

You need make a 3/4" high spacing template made from card stock that follows the outline of the cockpit rail rib, like this:

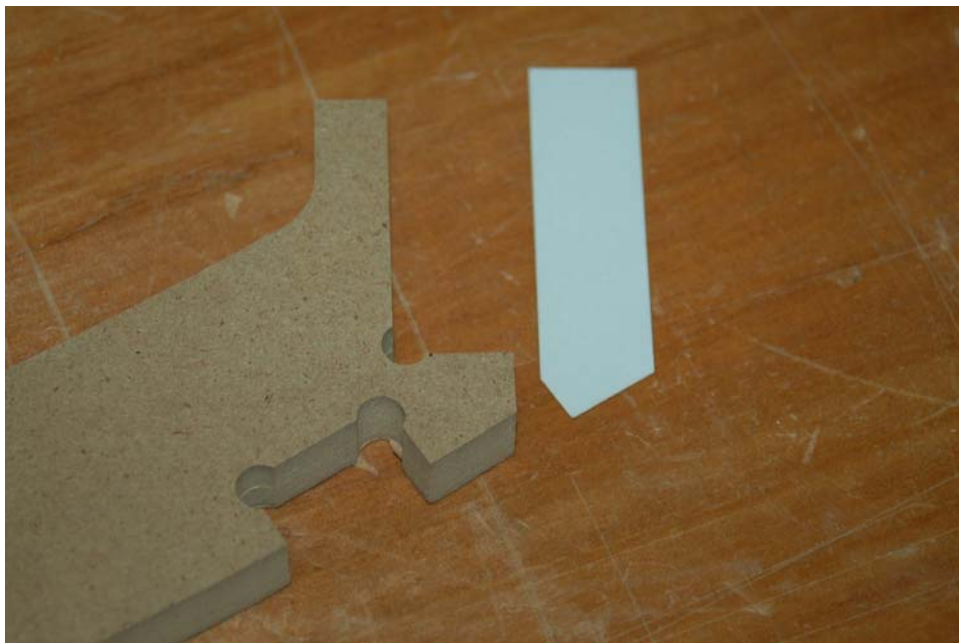

The Do it Yourself Cockpit Project – Series One

Set your table saw for a 32 degree cut and use the card template you just made to set the fence distance from the face of the blade:

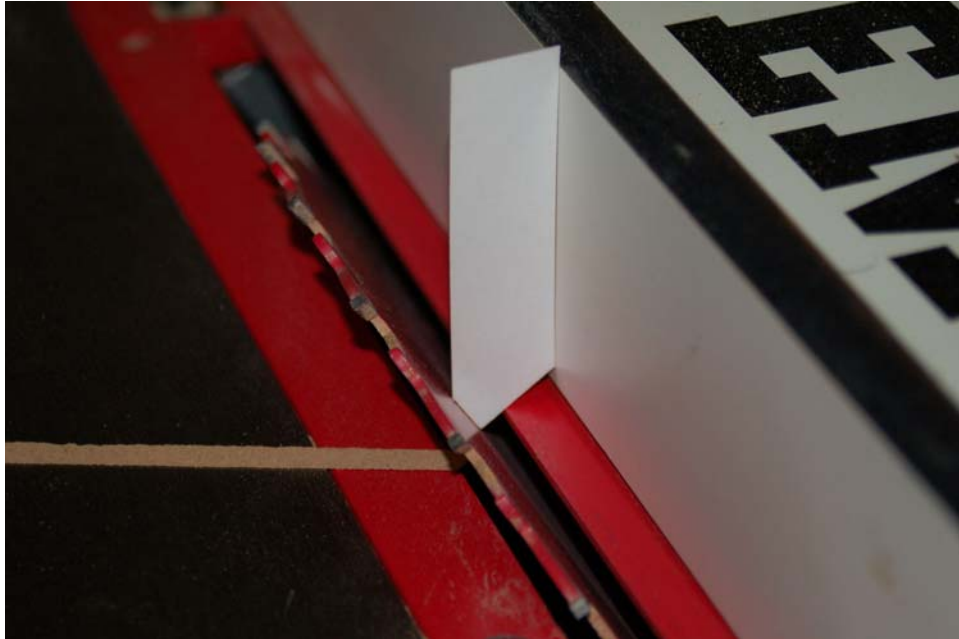

Carefully run the cockpit rail through the saw with the rail oriented just like you see in the template above – with the already beveled edge “facing” the fence. When you’re done, you should end up with this:

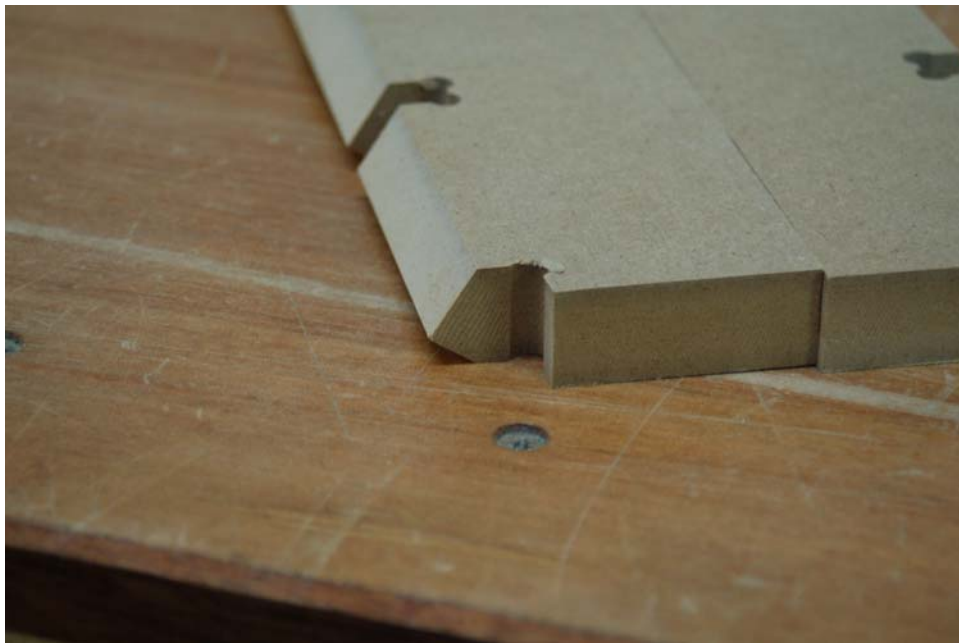

These two cuts ensure that the cockpit rail fits the cockpit rail ribs perfectly, without interfering with the first stringer that is placed in the notch right below the rail.

The Do it Yourself Cockpit Project – Series One

Remember those notes I had you write on the 2x4 parts about which was left, etc? Here's where that pays off:



This is how you want to align the first part of the side sub-frame. By lining it up on the floor like this, it tells you which is the inside face and which is the outside. This is important.

Measure 1" from the end and make a line on the outside face of both the 72" 2x4s on both ends. This is the alignment mark for the 2 5" 2x4s that make up the rest of the sub-frame assembly. When you've got the marks made, place the 2x4 against the outside face of the 72" board and screw it into place. When you're done with both sides, each should look like this:



The Do it Yourself Cockpit Project – Series One

Now you need to set up your combination square for $\frac{3}{4}$ " and run lines down the long end of both cockpit floor parts as well as centered along where the 5" 2x4 runs. This is about 1- $\frac{7}{8}$ ". The end result should look like this:

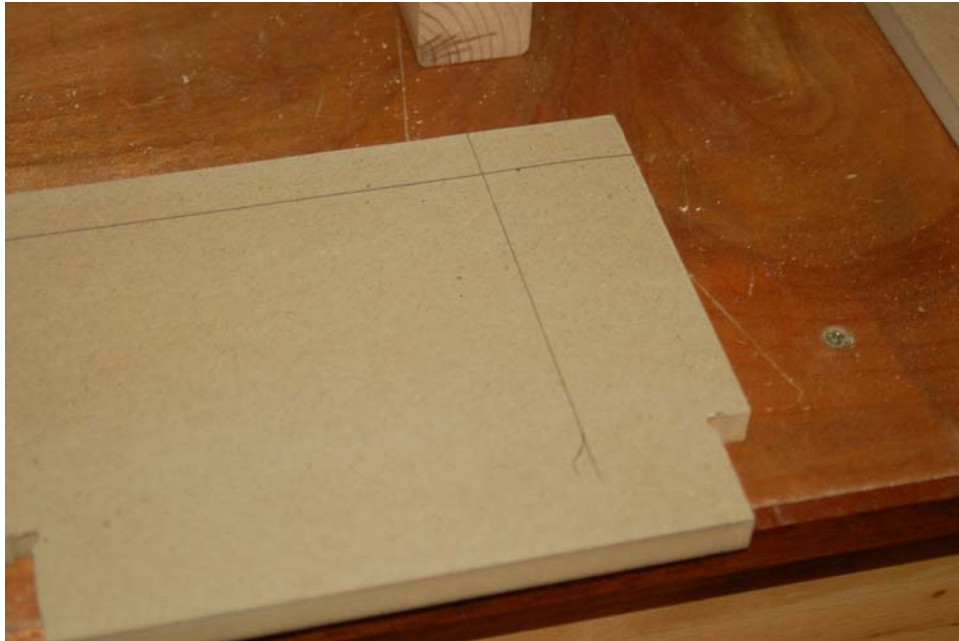

Note that the cockpit floor parts have a left and a right side. Don't do what I did and make lines on the same side of both parts. I had to flip one over and do it again. Starting at the corner where the two lines intersect, make marks every 4 inches along the long side of the floor. These are where you're going to put in the 1- $\frac{1}{2}$ " wood screws. For the screws that will go into the 5" part, measure back $\frac{3}{4}$ " from the outside edge of the part, mark that point and again at 3".

The Do it Yourself Cockpit Project – Series One

In order to help orient yourself with how the sides fit, just remember that the cockpit side floors have a big notch towards the aft end of each. Also remember that the notches face outward, “pointing” the same direction that the 5” 2x4 ends do. In order to keep it straight for myself before I moved to the next step, I set the sides up like they would be if they were installed:



The Do it Yourself Cockpit Project – Series One

After making sure that you're not making two of the same side, run a bead of glue along the top of the 2x4s. Set the floor down on the sub-frame and get it all aligned.

Drill a pilot hole at the line intersection on the aft end. Countersink and screw this down. Re-check the alignment against the 2x4. You want the "inside" edge of the floor to be flush with the "inside" edge of the sub-frame. When you're done, it should look like this:



Now go ahead and build the other side using the same steps we just did for this side. When you're all done, you should have this:



The Do it Yourself Cockpit Project – Series One

Now it's time to start setting ribs on those new floor frames you just built!

You want to make sure you get a good fit on these, but not so tight you have to nearly beat them to death with a hammer to get them set in. I can guarantee you that if you hit a rib too hard, you'll break it. It's happened to me twice, once on the prototype and again when writing this documentation. The notches are all .47" wide, which will serve both OSB and MDF users, however if you're going to use MDF, you **MUST** ensure that the fit is snug, but not so tight as to prevent you from installing the rib without resorting to beating it in with the mallet. I recommend using some 60 grit sandpaper glued to some 1/2" stock to help widen the slots a bit if you're using MDF.

The ribs that are installed on either end have a number of holes in them to accept the t-nuts for the end cap mounting. These holes need to be 5/16" in order to accept the barrel of the t-nut.

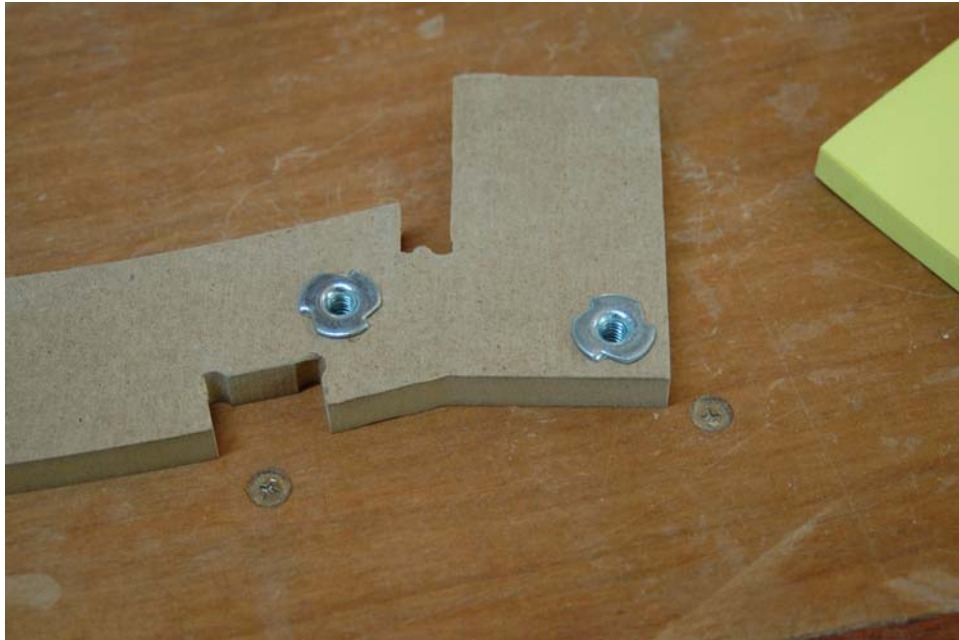

The easiest way to get these installed is to place the t-nut in the back of the rib and then insert a 1" hex head bolt with a washer on it from the other side. Tighten it fully to seat the t-nut into the material.

If you're not going to use the windscreen & canopy option, now is a very good time to install the six #10-24 T-Nuts (three each side) used to attach the lower instrument panel to the cockpit. Doing it now will save you grief about it later on.

The Do it Yourself Cockpit Project – Series One

The end ribs are installed by gluing & screwing the ribs into place. Draw a line that divides the base notch and mark center points at 5/16" from each edge:

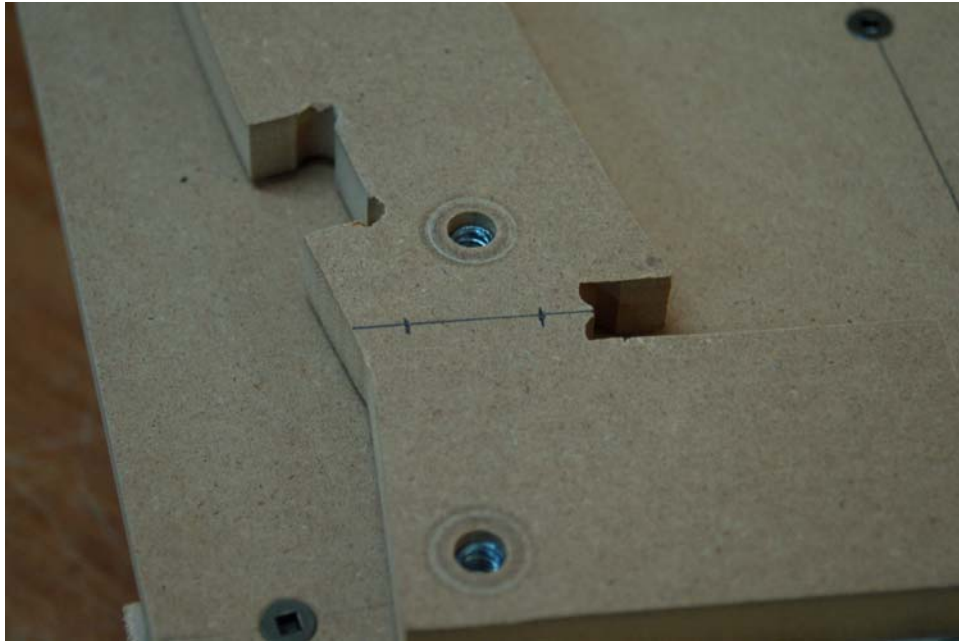

Apply glue to the mating surfaces on the rib and the cockpit floor and tap it into place. Drill two 3/32" pilot holes and countersink them. Install two 1" #6 flat head screws:

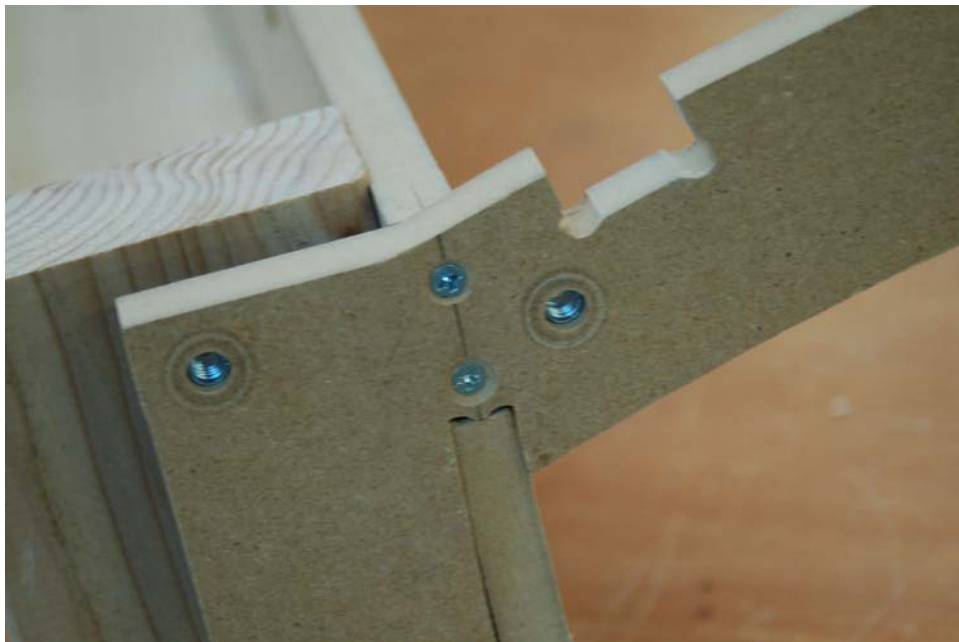

Note that putting a screw in "end-grain" on MDF is very weak. This is just done to stabilize the rib until the stringers and longerons are installed.

The Do it Yourself Cockpit Project – Series One

Following the appropriate drawing in Appendix A (left & right cockpit side parts arrangement), go ahead and install the remaining ribs. Repeat the steps outlined above for the other end-cap ribs.

Next, you'll need to install the fore & aft longerons as well as the cockpit rail. The aft longeron has two 5/16" holes in it to accept t-nuts:



The aft longeron is attached with glue and nailed into place with the pin nailer and 3/4" 18ga brads. If you're unable to use that method, you can also use 3/4" #6 screws, but make sure you take care installing them. MDF and OSB do not take screws very well edge-on. Pilot holes are required.

When installing the cockpit rail, make sure that the rib notches are not too tight – open them up a bit with 60 grit sandpaper if needed. You don't want to apply a lot of force when installing it or you run the risk of breaking one of the cockpit section ribs.

The Do it Yourself Cockpit Project – Series One

Apply glue to each notch and nail into place with 1” 18ga brads to each rib, or use 1” #6 screws, following the caution I mentioned above.



The Do it Yourself Cockpit Project – Series One

Next up is the fore top longeron:



Unlike the aft longeron, this part has no t-nuts installed in it. If you're building the windscreen for your cockpit, these holes are unused. If you're not going to build the windscreen, these holes are used to attach the top turtle deck assembly to the cockpit.

Now it's time to install the 1" x 1/2" x 72" stringers. The best way to make these is with a table saw and scrap sheet material left over from cutting the parts out. You'll want to cut a few test parts to get the width of the stringer just right. The stringer needs to be a tight fit into the notches in the ribs. Each rib notch needs to be glued:

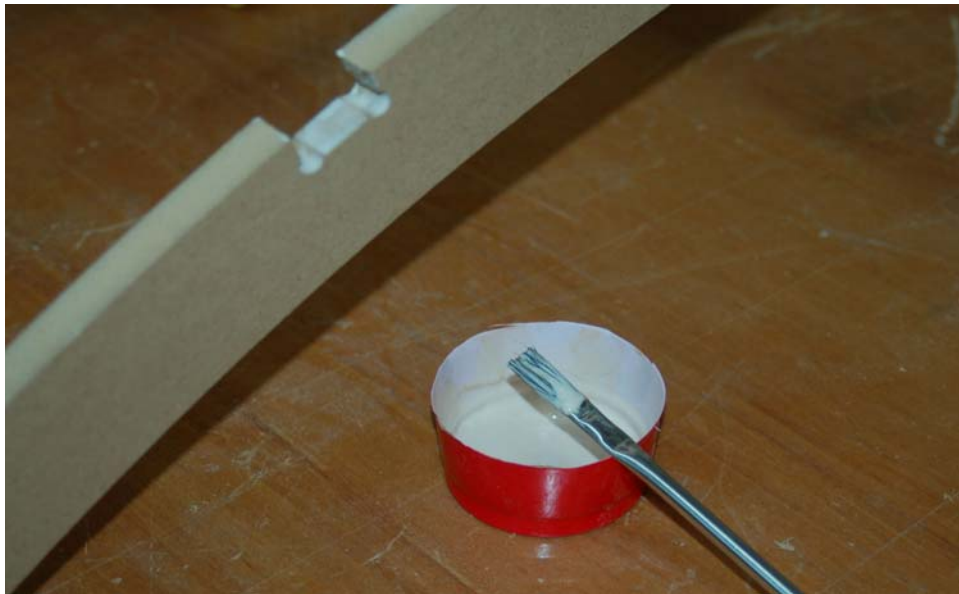

The Do it Yourself Cockpit Project – Series One

In order to seat the stringer in each rib notch, you'll need to use a clamp to press the stringer all the way into the notch:



Do NOT try to hammer the stringer into place. You'll only break the rib. By using the clamp as a press, you can get the stringer installed properly without stressing the rib structure. Repeat this process for all five stringers and you'll be done in no time!



The Do it Yourself Cockpit Project – Series One

The Do it Yourself Cockpit Project – Series One

Chapter Six - The Forward Turtle Deck & Instrument Panel Arch

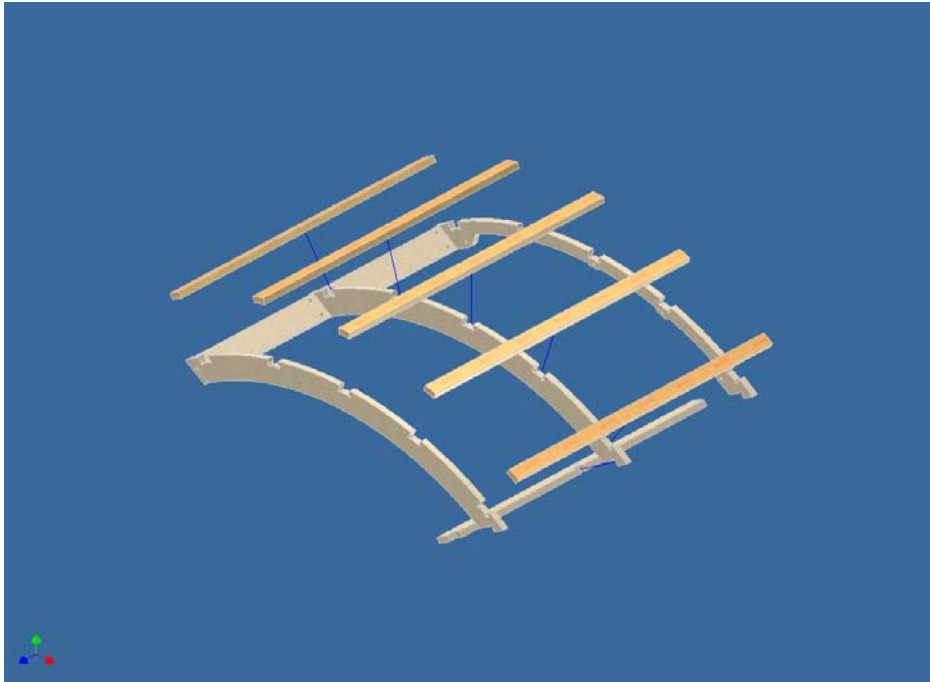

The Do it Yourself Cockpit Project – Series One

If you're going to build the windscreen & canopy, you can skip this section and move on to Chapter Seven, The Aft Cockpit Arch.

For this assembly, you're going to need the following materials:

Qty	Description
2	Part #3 – Forward Deck Rib
2	Part #4 – Forward Deck Rib, instrument panel mount
1	Part #4A – Instrument panel support arch
2	Part #8 – Forward Deck Longeron
2	Part #9 – Instrument panel support arch stringers
12	1/4-20 T-Nuts

The forward deck is a pretty quick build. You'll need to take care that the middle notch on the longerons is not too tight – just like building the sides, you don't want to break them while you're installing them.

The center notch in the longerons is offset a bit, so you need to make sure you orient the parts to face “forward” when you're assembling the deck. The easiest way to do this is to identify which end is the “front” end. You can do this from measuring from the end of the longeron back 11”. The 11” mark will put you at the center of the mounting holes on the “forward” end of the center notch. Also, the “forward” end of the center notch is 11-3/4” from the forward end of the longeron. Mark the forward end of the longerons with an arrow, like this:



The Do it Yourself Cockpit Project – Series One

You want to start off by mounting the middle rib (Part #3) to each longeron at the middle notch, like so:

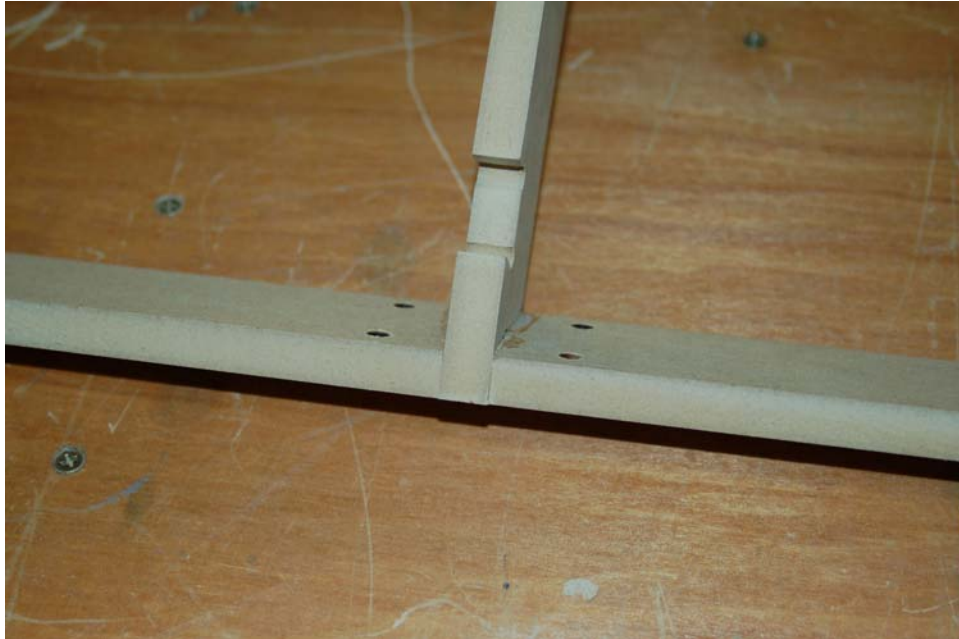

I will guarantee you without a shadow of a doubt, if you force the rib into that notch, you'll snap the longeron in half. I know; I just did it myself. Make sure you sand the middle notches so the rib fits snugly, but doesn't require much force to insert. Glue the rib in place and pin it from below with one or two 18ga 3/4" brads.

The Do it Yourself Cockpit Project – Series One

Next, you'll add the second large rib to the front of the forward deck assembly:



When attaching this part, you'll need to put one 18ga brad in the end and two on the bottom, like so:



It's kind of difficult to see, but the brads went in where you see the material dimpled. Don't forget to glue this down!

The Do it Yourself Cockpit Project – Series One

Next you're going to install the instrument panel support rib – it doesn't actually support the instrument panel, but it allows longer screws to be used if needed:

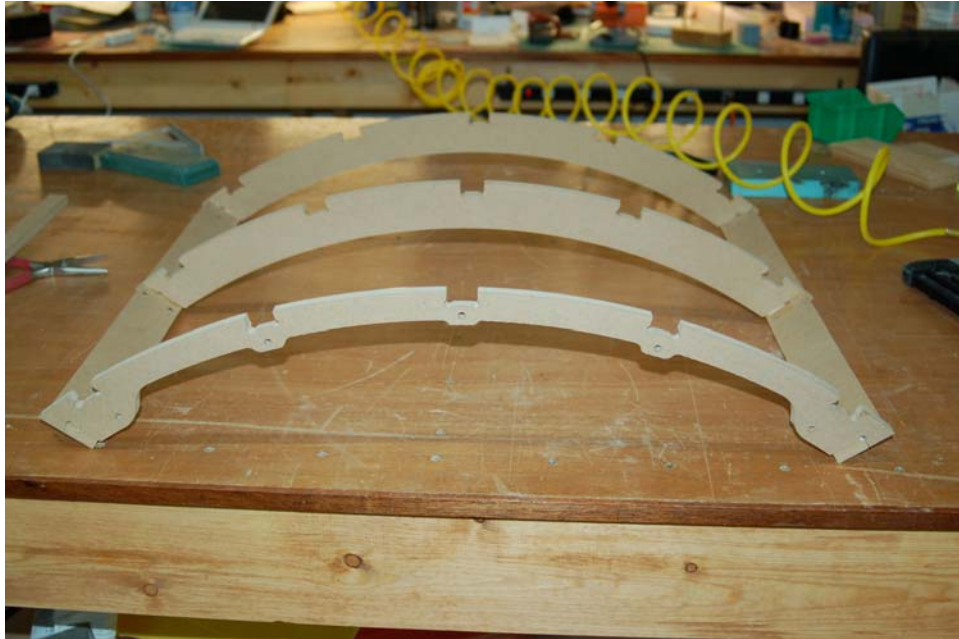

Now it's time to add the stringers. Go ahead and place the very top stringer first, like so:

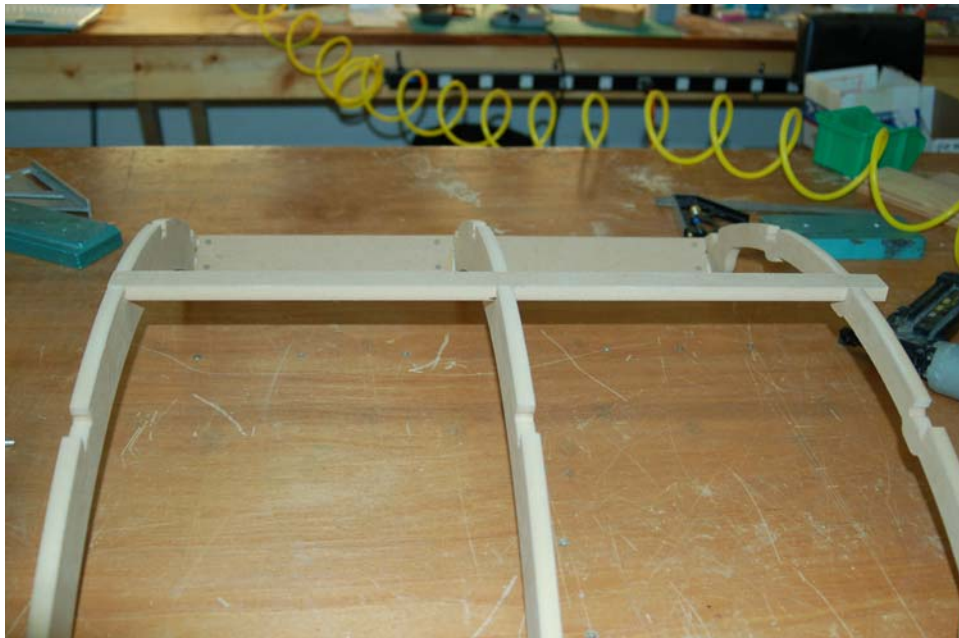

This one is done first because it will allow you to ensure that the ribs are all square to one another. To do this, measure the distance between the ribs at the base of each rib, and compare that measurement to the same one taken at the top stringer location.

The Do it Yourself Cockpit Project – Series One

Install the apply glue to the stringer notches and insert the stringer. Once you've done that, you can tap the middle stringer a bit to get it to match the bottom measurement. Once you have it square, pin it in place.

Next, put in the bottom stringers on either side:



You can go ahead and get the rest of the stringers installed. Once you've got any extra stringer length trimmed off, set this part aside for now. Make sure you've got it on a level surface where the glue can dry. You don't want this assembly warping on you.

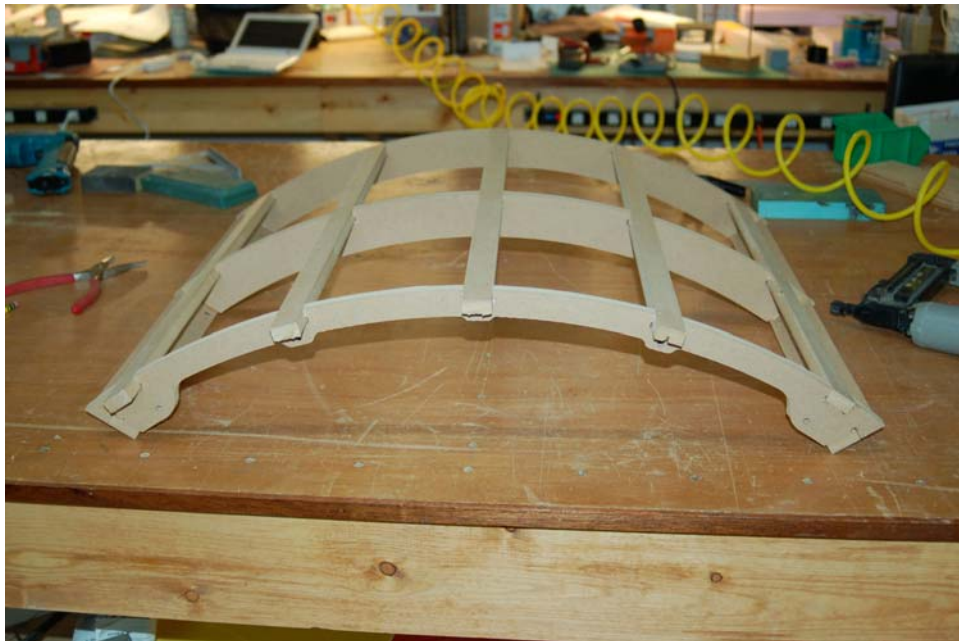

The Do it Yourself Cockpit Project – Series One

At this point you should over-drill the mounting holes (bottom two holes on each end) and install the 1/4-20 t-nuts as shown below:

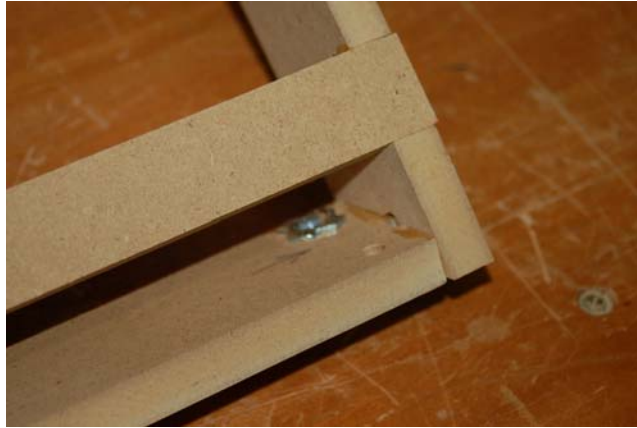

Next you are going to need to install the four 1/4-20 T-nuts in the forward frame:



It's very hard to see, but there is a white dot next to each one you need to have installed.

Now it's time to build the instrument panel arch. This assembly was designed in order to support your instrument panel while allowing you to remove the forward deck. By keeping it a smaller part, it can be more or less “permanently” mounted so you don't have to remove the panel in order to work on it.

The Do it Yourself Cockpit Project – Series One

We'll start out by gluing and pinning the instrument panel arch longerons and the "top" stringer, like this:

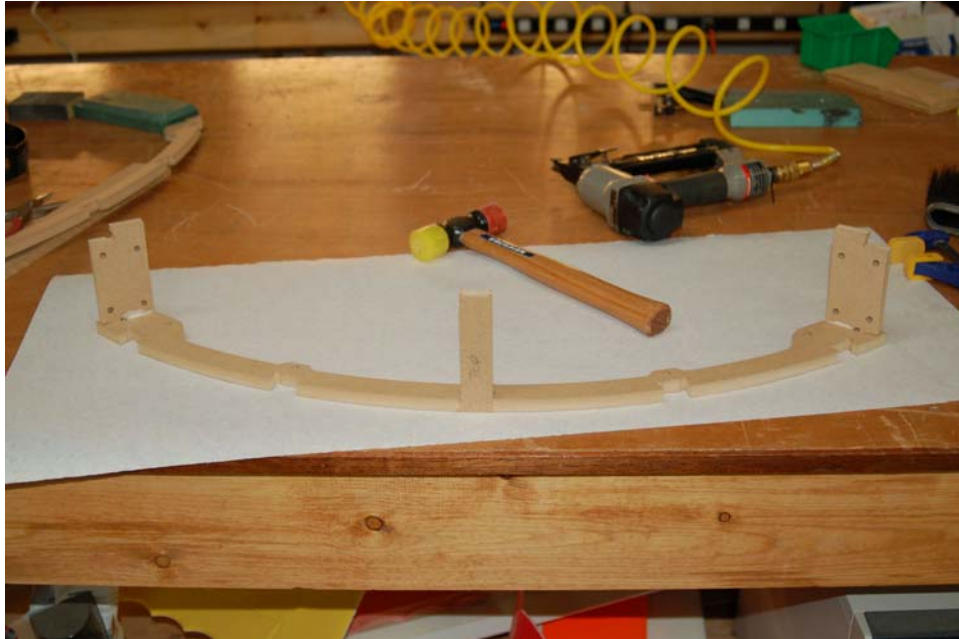

To make the stringers the correct length, it would be easier to just create 5 stringers that are the same length as the panel arch longerons. It's pretty hard to read out 4.235" on a measuring tape.

The Do it Yourself Cockpit Project – Series One

The instrument panel arch is started this way because it's easier to make sure everything stays aligned long enough for you to get it assembled. Once the step above is done, attach the other instrument panel arch rib:

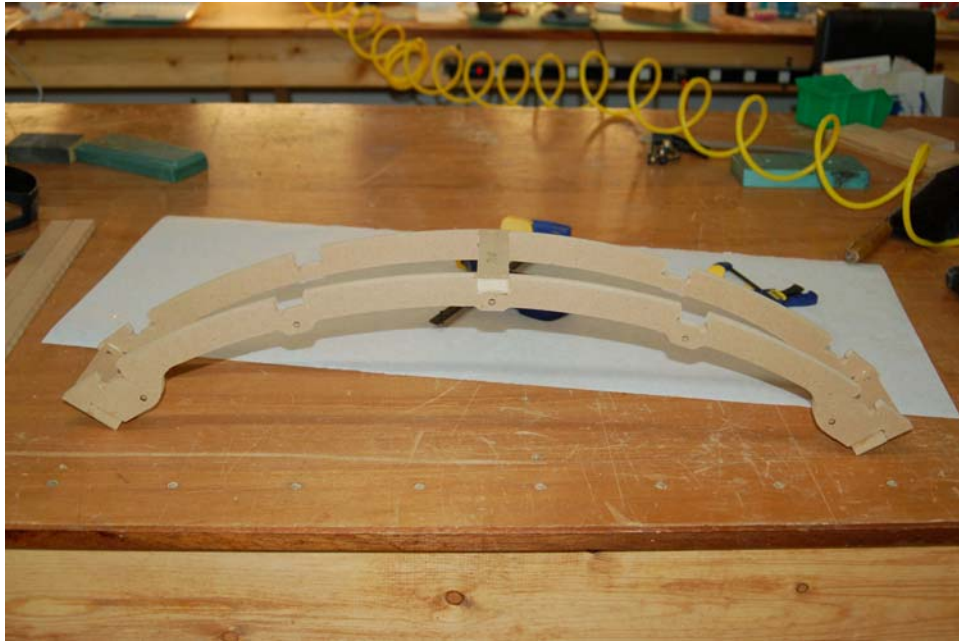

When you've got that done, install the stringers at the base on each end and then finish mounting the other two stringers.

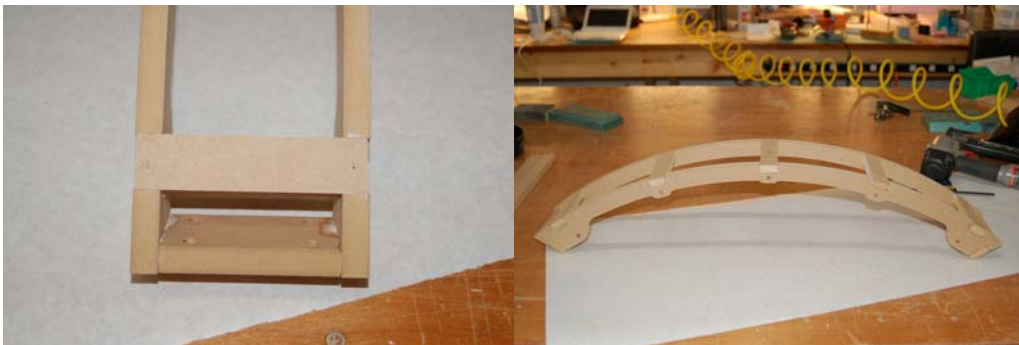

The last step is to decide how you want your instrument panel mounted. My original design calls for the instrument panel arch to be installed so that the rib with the mounting holes is closer to the front of the cockpit. This allows for an instrument panel "brow". However, you're welcome to flip the part around and mount it so that the panel is closer to you. The only reason I mention this now is that you're going to have to decide where you install the #8-32 threaded inserts.

The Do it Yourself Cockpit Project – Series One

The threaded inserts are very easy to install, but be aware that installing them in MDF will cause some splitting in the material perpendicular to the hole they're being inserted into.



Below you can see what I mean about the splitting issue. You can buy MDF specific threaded inserts that will greatly reduce this problem. They're available from McFeely's as well.



The minor tear-out isn't so much an issue with OSB. Note that you can use t-nuts if you like, but you'll need to countersink them with a forstner bit to make sure the t-nut isn't proud of the surface. Otherwise the forward turtle deck won't fit properly.

The Do it Yourself Cockpit Project – Series One

You're also going to want to drill out the base plate to 5/16" and get the 1/4-20 t-nuts installed now. Use the "lower" holes as shown in the image below:

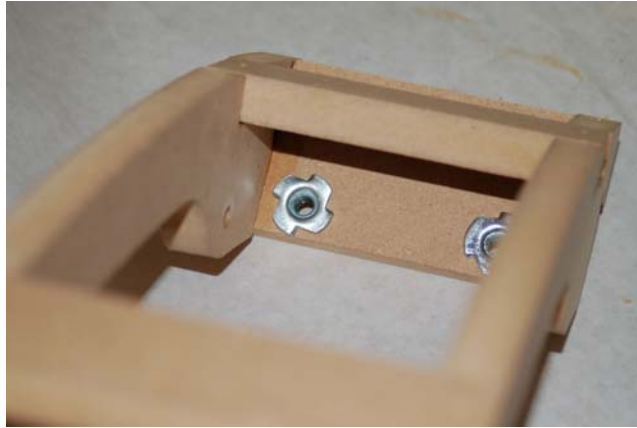

All that remains is skinning the arch and I'll cover that later.

The Do it Yourself Cockpit Project – Series One

The Do it Yourself Cockpit Project – Series One
Chapter Seven - The Aft Cockpit Arch

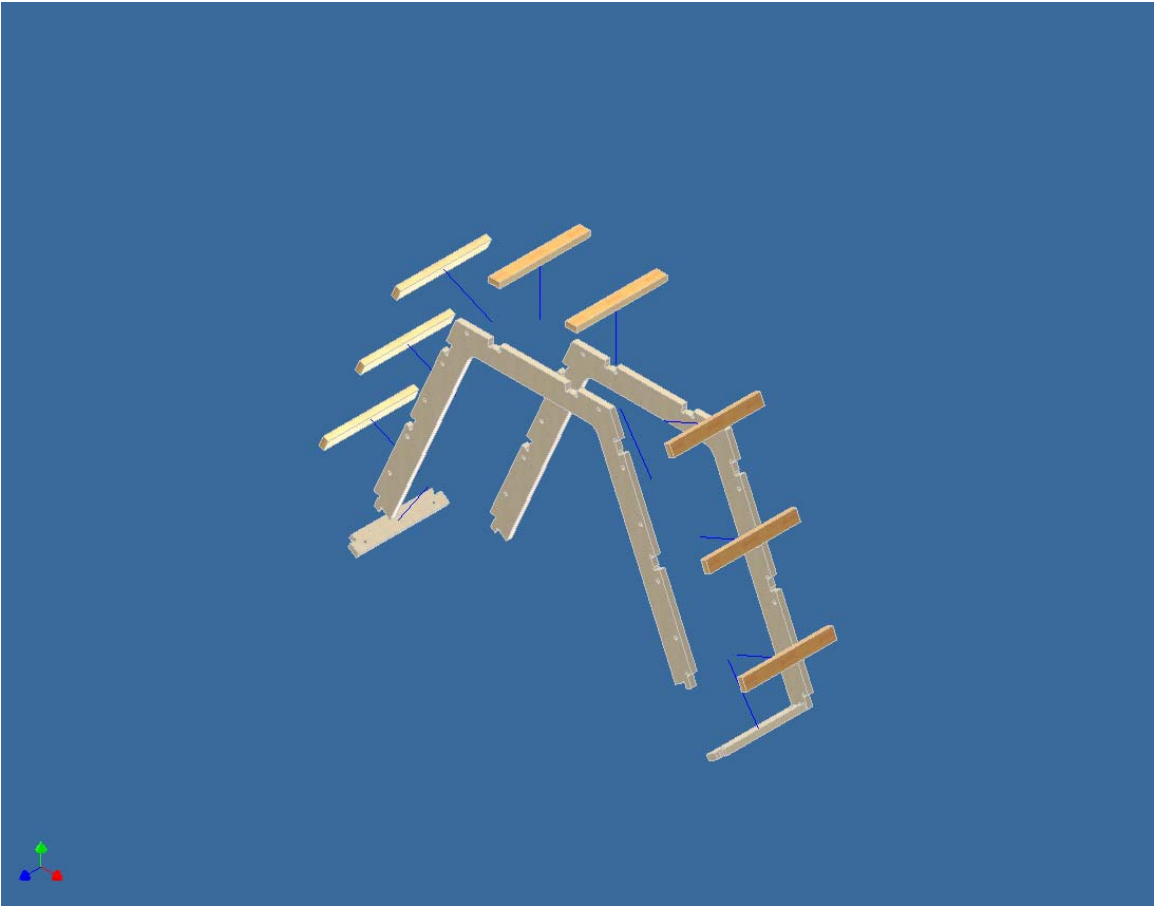

The Do it Yourself Cockpit Project – Series One

For this assembly, you're going to need the following materials:

Qty	Description
2	Part #25 – Aft cockpit arch – squared (or 4 halves)
2	Part #5 – Aft cockpit arch longeron
8	1" x 1/2" 8.23" stringer
20	1/4-20 T-Nuts

If you've cut Part #25 as four halves as I show in the plans, you're going to need to glue and pin them together before we can continue:

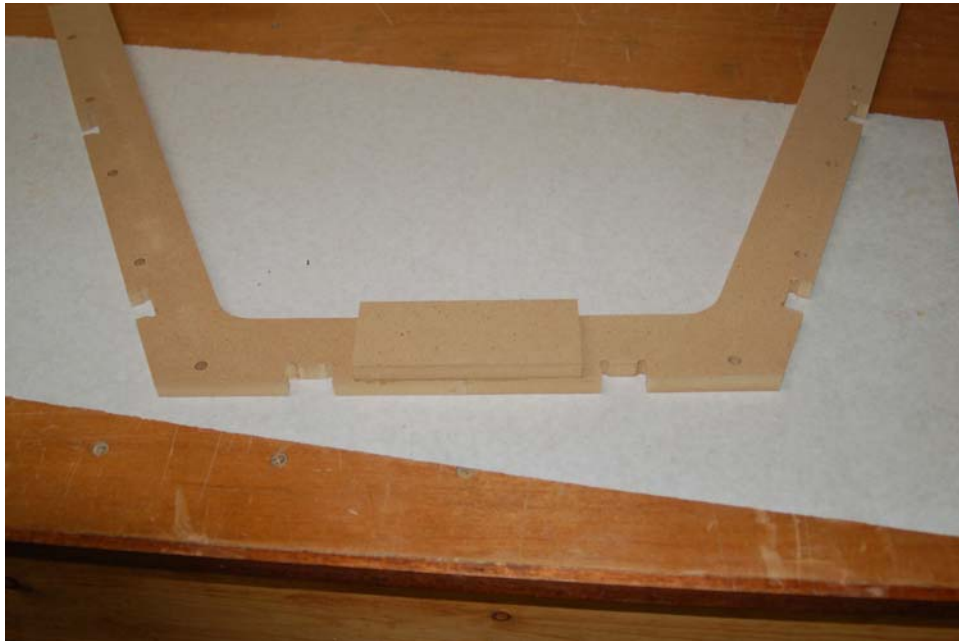

What I've done here is glue the two frame halves together and then attached a 1-7/8" x 5" x 1/2" thick doubler plate in order to help hold it together. This is one part you want to leave alone until the glue is dry. It's also important to make the butt joint as tight as possible. Both frames need to be as identical as you can make them in order that the completed assembly fits the cockpit frame.

While you're waiting for the glue to dry, go ahead and cut the 8 stringer parts you'll need to finish this assembly. You should have enough stringer scrap from the other parts to be able to do this without having to cut any new stringers. You can cut the stringers to 8-1/4". It's close enough to the 8.23" design that it won't matter much.

The Do it Yourself Cockpit Project – Series One

When the glue is dry, install the two longerons in one of the arch halves:

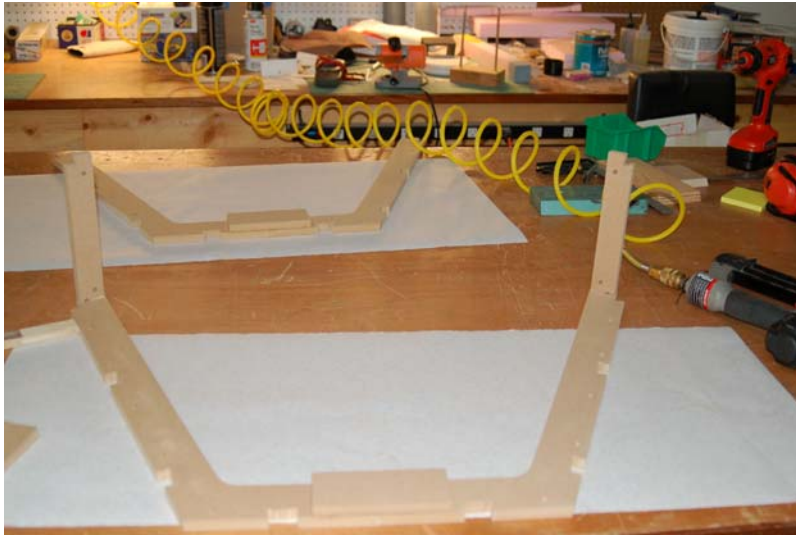

You should pin these into place as well to hold them. Next, you need to install the top two stringers and set the other half of the aft cockpit arch:



When installing the stringers, make sure you glue and pin them. Don't force them – sand the notches a bit if you need to.

The Do it Yourself Cockpit Project – Series One

When you're done, the assembly should look like this:



Next, install the remaining stringers:

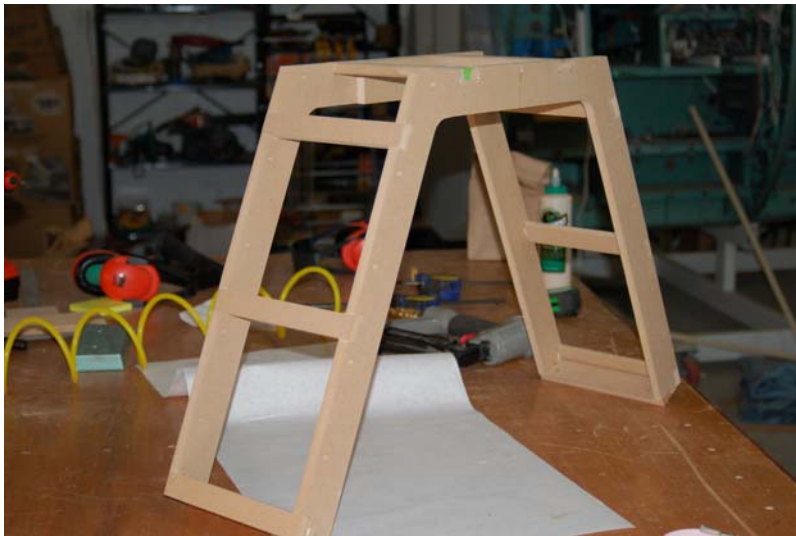

The last step is to install the 20 ¼-20 t-nuts into the frame.



The Do it Yourself Cockpit Project – Series One
Chapter Eight - Skinning the Cockpit Sides



The Do it Yourself Cockpit Project – Series One

For this assembly, you're going to need the following materials:

Qty	Description
2	73" x 27-5/16" 1/8" Tempered Hardboard

When skinning the cockpit, you can opt to not use the 1/8" Tempered Hardboard and use aluminum sheet instead. I won't cover how to attach it here, but the layout instructions that follow will apply.

Note: If you have a router, cut the skin to 75" in length. This will give you some extra "overhang" that will allow you to have perfect coverage at the end caps in case there is a length error due to a slightly loose spacing tolerance on the sides. You can trim off the extra skin with a trim bit after you've assembled the cockpit and installed the end caps.

The first thing you'll need to do after your skin material is cut is to draw a series of lines on it that will allow you to properly attach the skin to the side frames.

Measuring along the long axis of the skin material, I want you to draw a series of 9 lines:

No.	Measurement
1	1/2"
2	12 1/4"
3	24 1/4"
4	28"
5	36 1/4"
6	48 1/4"
7	60 1/4"
8	63 3/4"
9	72

These lines are along the "front" edge of each rib in the cockpit. All your brads will be used about a 1/4" aft of each of these lines.

The Do it Yourself Cockpit Project – Series One

Next, you need to make 6 parallel lines along the long axis – these will define the centerline of each stringer. Those measurements are:

No.	Measurement
1	1 1/8"
2	7 1/4"
3	13 1/2"
4	19 1/2"
5	25 1/2"
6	27"

Because the sides are mirror images of themselves, you'll need to make sure that you don't create two identical skins.

The easiest way to do that is to create layouts with the horizontal line set starting on your left (the 1/2" mark is the "start") and call that the "left" side. Create the layout on the "right" sheet just opposite that, with the 1/2" line starting on the "right" end of the sheet as you're facing it. The long edge farthest away from you will be the "top" edge for both parts and that is where you measure to make your stringer center lines.

When you're done, you should have a layout that looks something like this:

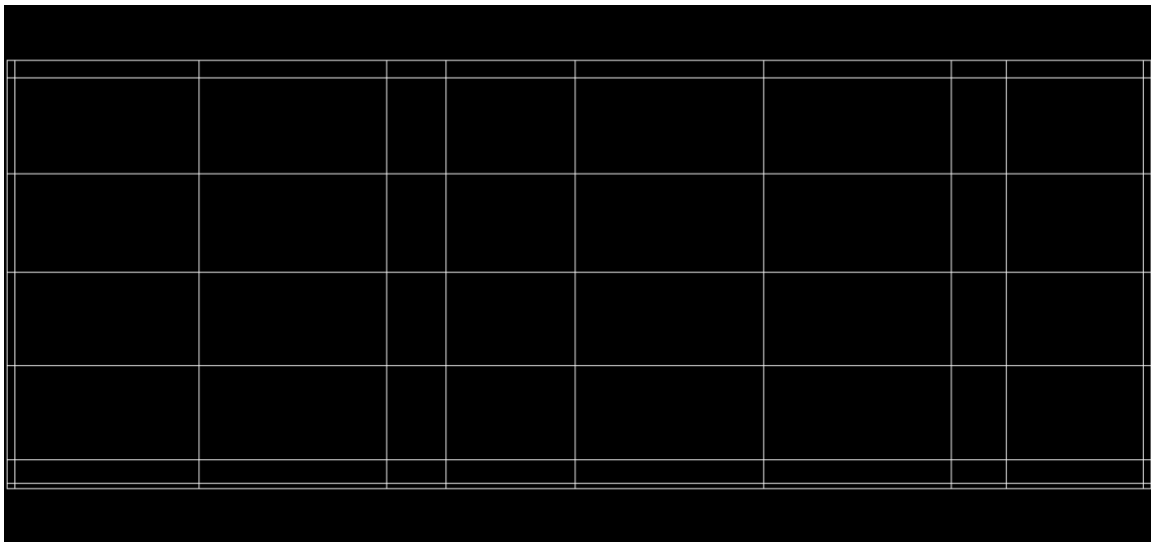

This drawing shows the general layout of the whole skin panel and is representative of what you should have on the left side. Now it's time to attach the skin. You'll need your pin nailer and 1/2" brads for this. You can also use screws if you like, but I won't outline that process here. (Hint: get a rivet fan to help you lay out where the screws go!)

The Do it Yourself Cockpit Project – Series One

One important thing to mention – if you're using a pin nailer to attach the skin, make sure that you've got the depth setting adjusted correctly. The skin material is soft and it's very easy to drive the brad all the way through it. This is a lesson I learned building the production model shown in this manual. When correctly set, you should see a result like this:



You should be able to see the silver head of the brad and it should be flush with the surface or just a little bit below. If you have problems with setting the depth adjustment, err on the side of under-driving the brad. You can always go back over them later with a hammer and a nail set.

Take a bottle of glue and an acid brush and spread the glue in an even and thin layer all over the framing, like this:



The Do it Yourself Cockpit Project – Series One

Set the skin on the framework and align the line at the ½” mark with the leading edge of the first rib (forward) like this:



This overhang covers the end caps. If you've made any slight error in building the sides, this won't completely cover the end cap. You're better off making the skin sheets a bit over-length and trimming the extra off with a router and a flush trim bit as I mentioned earlier.

The Do it Yourself Cockpit Project – Series One

Align the top edge of the skin with the top edge of the front and rear longerons – this will result in a bit of an overlap along the cockpit rail. This isn't a problem and you'll be trimming it off later on. When you've got it aligned, clamp it and start nailing it down with the pin nailer.



I use a few extra clamps to support the framework off the table in order to make it easier to work on. Work your way back and forth, nailing the skin down as you go. If you're careful and take your time, this shouldn't be too difficult to get right the first time.

After you're done applying the skin, check along the first and last ribs to make sure that the skin is firmly attached. It may lift a bit and require some clamps to keep it in place until the glue dries. This holds true for the longeron and cockpit rail areas. You can't use too many clamps. When you're done, it'll look like this:



The two white blocks are a temporary “band-aid” used to reinforce a rib I broke during the assembly of this side. *Don' force-fit the ribs!*

The Do it Yourself Cockpit Project – Series One

After the glue has dried, you need to trim any “extra” skin that stands proud of the cockpit railing. For the cockpit I built for this instruction manual I used a router to quickly “plane” off the extra material:



To do this, you just lay a 1/8” strip of hardboard down on the cockpit rail to act as a stand off. Set the router bit depth so that when the router is sitting atop the spacer, it stands way from the surface of the cockpit rail about the thickness of a business card. From there, you just plane the material off with the router, but *only* in the material that lies along the cockpit rail itself.



The Do it Yourself Cockpit Project – Series One

When you've planed it off, just sand it smooth with some 220 or 300 grit sand paper. If you don't have a router, 60 grit sandpaper glued to a scrap section of 2x4 will work equally well. Just be careful not to scuff up the top of the cockpit rail.



Chapter Nine - Skinning the Forward Turtle Deck and Instrument Panel Support Arch



The Do it Yourself Cockpit Project – Series One

For this assembly, you're going to need the following materials:

Qty	Description
1	32" x 24-1/2" 1/8" Tempered hardboard skin
1	32" x 4-5/16" 1/8" Tempered hardboard skin
40"	1/8" scrap lite ply for filler

Skinning the forward parts is pretty straightforward. The first thing you need to do is mark the nailing centerlines on your skin material.

For both the forward turtle deck and the panel arch skin, you're going to mark a center line at 16" along the short length of the material (24-1/2"). To either side of this centerline, please draw lines at 6-3/4", 14" and 15-5/8".

Pick one edge to be the leading edge and draw a line along the 32" width at 12-9/16". This marks the middle of the rib in the center of the forward deck. The instrument panel arch component doesn't require this extra line.

Next, you need to fill in the spaces between the ribs with lite ply in order to give yourself a solid nailing surface.



The Do it Yourself Cockpit Project – Series One

Sand down the filler parts in order for it to be flush with the rib profiles.



Once this is done, set it aside for now. You need to prep the forward deck face plate. This basically means you're going to need to countersink the holes if you haven't already.



Now attach the face to the forward deck – you only need to use two screws as this is only temporary. I imagine you'll notice that the example forward cap shown here has more holes in it than what is shown on the plan. This is why I built this along with you. You don't get the extra holes I forgot to delete from the plans when I made the “instruction manual” cockpit.

The Do it Yourself Cockpit Project – Series One

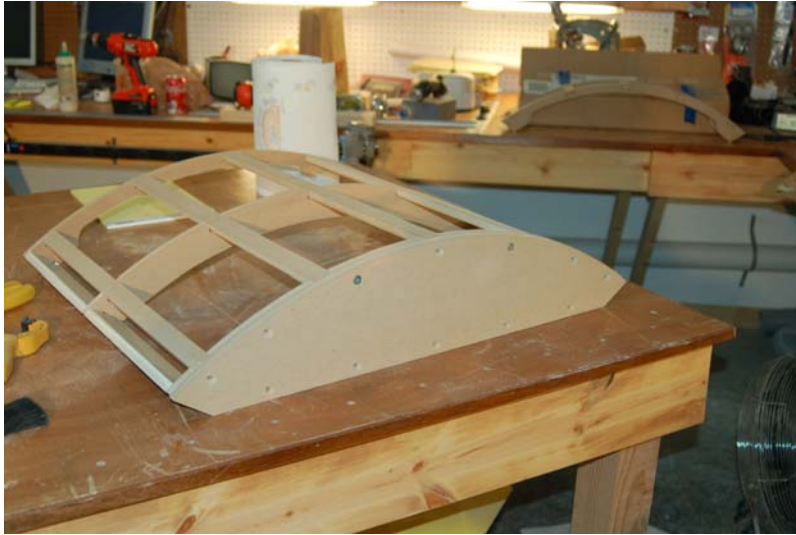

Now you need to mark the center line on the face and on both ends of the center stringer in order to make sure the skin stays aligned.

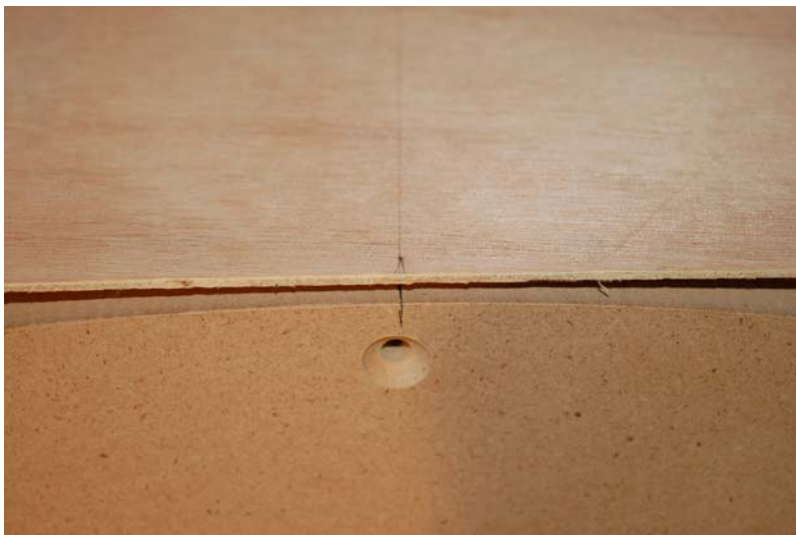

You'll note that the skin isn't hardboard. For this example I switched to a 1/8" Luan door skin to illustrate an alternate skin material. Personally, I'd stick with 1/8" hardboard unless you plan on staining and varnishing your cockpit to make it resemble some really cool furniture. Might help it get past She Who Must Be Obeyed too!

When you've got the centers marked, lay glue on all the ribs and stringers like you did for the cockpit sides and set the skin down so that the center mark along the 24-1/2" length matches the center marks you just put on the framing. Make sure that the leading edge of the skin is even with the outside face of the forward deck face plate. Clamp the skin on the back rib and then you can remove the forward plate. Clamp at the center like you did in back.

The Do it Yourself Cockpit Project – Series One



Using your pin nailer, tack down the skin along the center stringer. From there you can begin to attach the rest of the skin working your way out from that center point. It helps to have someone help you hold the skin down as you go. This is what it looks like finished:



The Do it Yourself Cockpit Project – Series One

The instrument panel arch is assembled the same way:



The Do it Yourself Cockpit Project – Series One
Chapter Ten - Skinning the Aft Cockpit Arch



The Do it Yourself Cockpit Project – Series One

For this assembly, you're going to need the following materials:

Qty	Description
2	19-5/8" x 9-1/4" 1/8" Tempered hardboard skin
1	14-1/2" x 9-1/4" 1/8" Tempered hardboard skin

In order to skin the Aft Cockpit Arch, you're going to have to get the front and back caps finished. (Parts #16 & 17) This basically means you're going to need to drill all the countersinks:

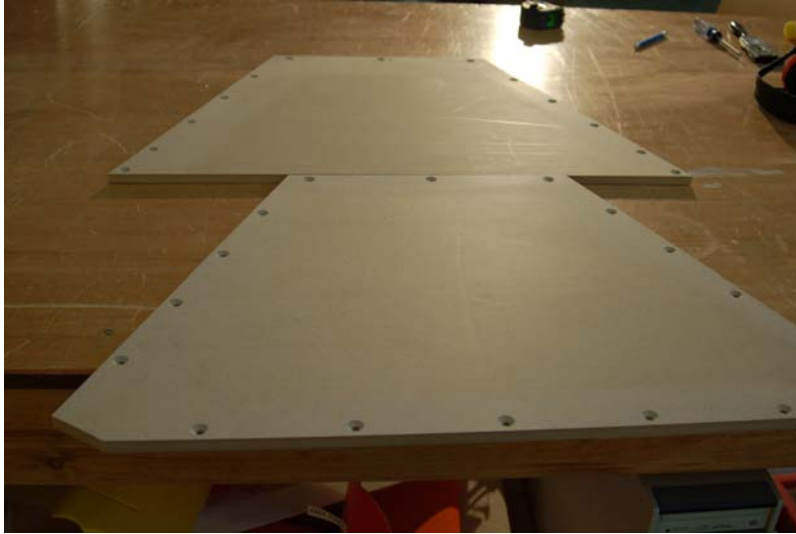

Once you've got those done, you need to attach them to the aft cockpit arch framework. You only need to use four screws per side as you'll be removing these after the skin has been attached.



The Do it Yourself Cockpit Project – Series One

During the writing of this chapter, I accidentally forgot a step – there are two parts that need to be installed to support the corners where the two skin panels meet.

To make these two parts, take some scrap 1"x1/2" stringer material and cut a 24 degree bevel into it. Approximate it as best you can if you don't have a table saw.

These parts need to fit snugly at the top corners of the arch frame, but not so tight that they spread the arch frames.



When you install the skin in the next step, you'll have something to tack the skin ends to. Sorry for the oversight!

Now you need to take your "side" skins and draw lines 1/2" from the edge, along the long edge. This marks where the outside edge of your nailing area is. You can put brads **inboard** of these lines, not outboard. This is to make sure that you can remove the assembly caps later on.

Next, you'll need to mark a line 1/2" from the bottom edge, one at 8-13/16" and one at 17". These mark the center lines for the stringers.

Apply glue to only the arch parts itself, not the end caps. You don't want the skins sticking to parts you're going to remove in a few minutes.

Applying the top skin is just as easy as the sides. Draw lines 1/2" in from the long edges, just like you did with the side skins. Then, you need to draw a line at 3-3/4" and 10-3/4". These are the centerlines for the top stringers. Glue & nail in place like the sides. Now remove the end caps and wipe off any excess glue on them.

The Do it Yourself Cockpit Project – Series One

The end result should look like this:



The Do it Yourself Cockpit Project – Series One

Chapter Eleven - Finishing and Installing the End Caps

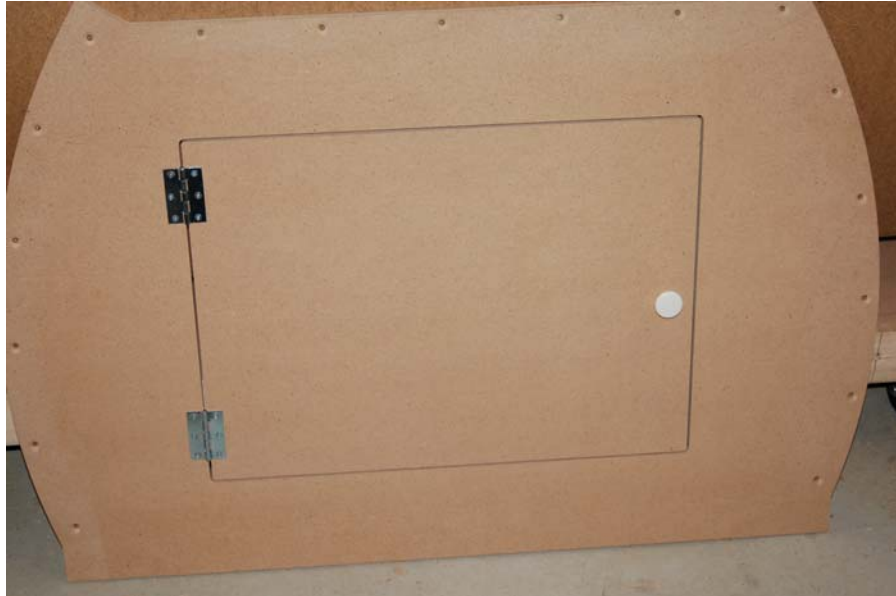

The Do it Yourself Cockpit Project – Series One

For this assembly, you're going to need the following materials:

Qty	Description
2	Part #18 – End Cap
2	Part #19 – End Cap Access Door
2	Part #7 – End Cap Doubler
4	2-1/2" Utility hinges with removable pins
2	Magnetic Cabinet door catches
2	Knobs
4	#6 1" wood screws
20	1/4"-20 T-Nuts (10 if you're building the Canopy & Windscreen)
44	1"-1/4" Flat head screws (34 if you're building the Canopy & Windscreen)

First up, you'll need to get the t-nuts set into both End Cap Doublers (Only one is used for the Canopy & Windscreen model).

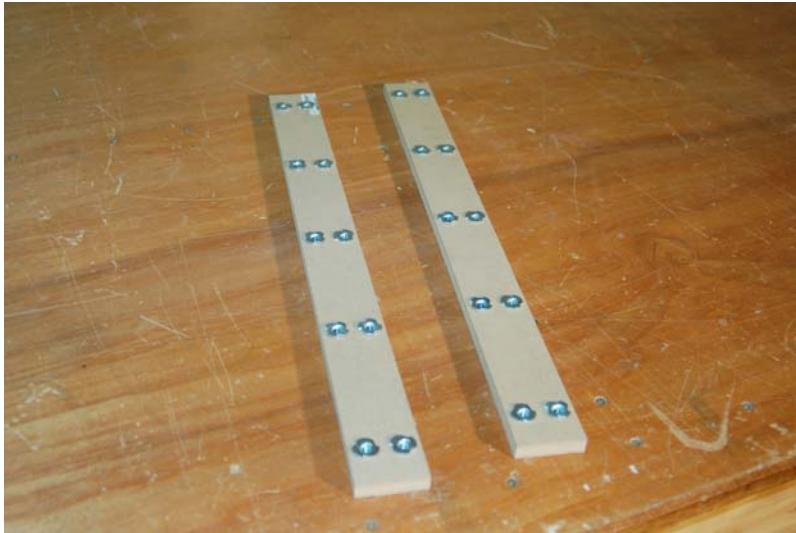

If you're building the canopy & windscreen option, it's okay to have drilled the top row of holes in both the end caps. You can cut down the 1" 1/4"-20 screws and epoxy them into the holes.

Next up, you're going to have to countersink all the 1/4" mounting holes on both end caps as shown on the next page.

The Do it Yourself Cockpit Project – Series One

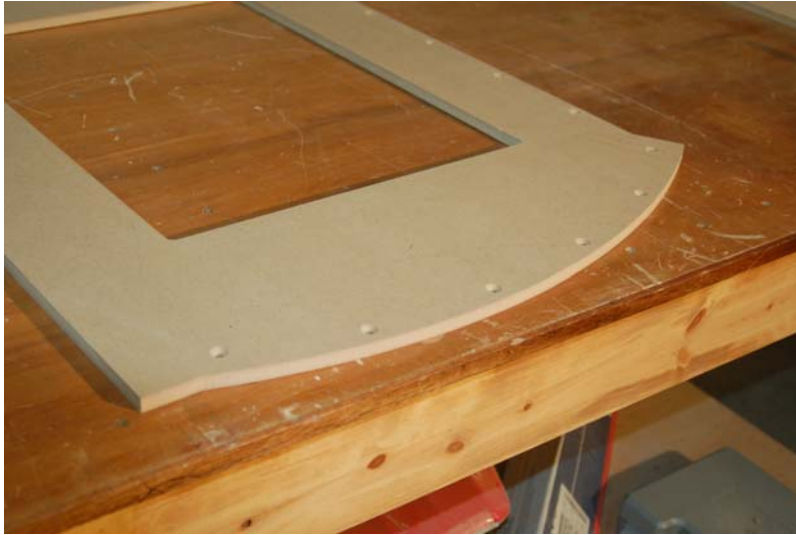

Now you need to get a couple of lengths of scrap material and use it to support the end cap, face up as shown:



This is done to allow the support to give you a little space under the part for the hinge screws to penetrate as well as to support the end cap door at the same height as the end cap itself.

The Do it Yourself Cockpit Project – Series One

Now you want to set the end cap door in place and then put spacers all around it to ensure that the door will remain centered in the opening while you install the two hinges:



The spacer thickness will be determined by how well you cut out the hatch. Since mine are cut on the ShopBot, the spacing is 1/8" all around because I used a 1/8" diameter cutter to cut out the door.

Next, you want to place the hinges 1-1/4" from the top and bottom edges of the door opening. Make sure that the end of the hinge that the pin is removed from is pointing to the top of the end cap as shown below:

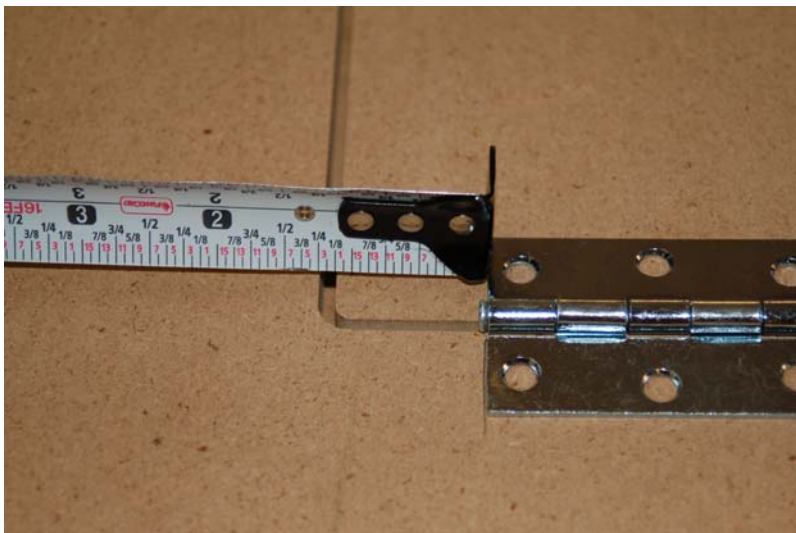

The Do it Yourself Cockpit Project – Series One

I recommend using a self-centering pilot hole bit to drill the holes for the hinges. The one I used is from Rockler and is called a 5/64" Insty-Drive Self Centering HSS Drill Bit for #4 wood screws. The reason I used this is that the self-centering aspect of the tool ensures that the pilot hole will be placed in the center of the hinge mounting hole. This will prevent the flat head mounting screw from shifting the hinge away from where you wanted it as would happen if the hole was drilled off-center from the hinge mounting hole.

When you're done, the hinge installation should look something like this:



Now it's time to carefully remove the spacing blocks from around the door and flip the end cap face down. The next step will be to install the magnetic door catch.



The door catch is just a simple magnetic latch that you can find at pretty much any hardware store. Cut a scrap of material roughly an inch wide by $\frac{3}{4}$ " high and long enough to support the magnet assembly as shown above.

The Do it Yourself Cockpit Project – Series One

Attach the mounting block to the back side of the end cap, right about the middle of the door. I used both glue and a couple of 1" 18ga pins:



Now install the metal plate on the door itself. After you've done this, set the magnet assembly on the metal plate and screw it into the mounting block as shown below:



The Do it Yourself Cockpit Project – Series One

Two #6 screws should be used to reinforce the door catches like so:



This will help prevent pressure on the door from knocking the magnetic catch off the back of the end cap.

The next thing you're going to want to do is take down the sharp points of the screws that you used to mount the hinges. They're going to be sticking up just a little bit proud of the surface. A careful pass with a die grinder or a metal file will take care of this quickly:

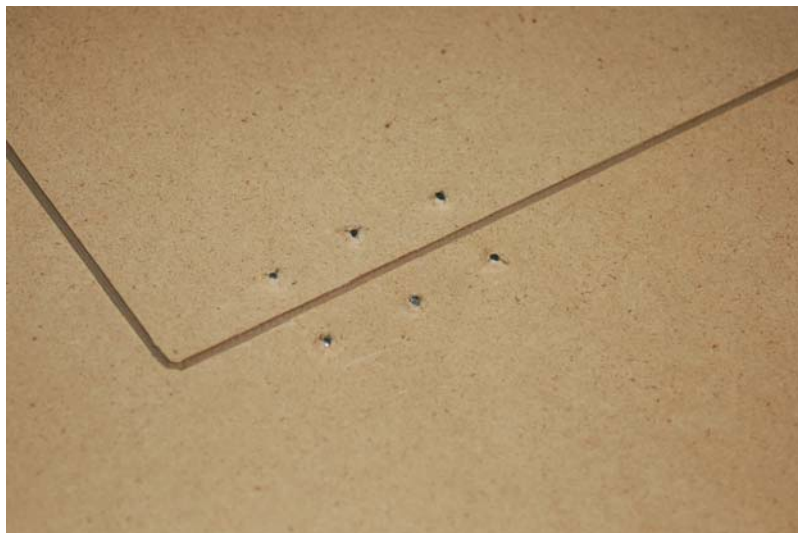

Alternately, you can back the screw area with some 1/2" scrap stock that's been glued in place.

The Do it Yourself Cockpit Project – Series One

All you have left to do is install whatever knob or handle that you'd like to use and you're done!



In the next chapter, I'll cover assembling the cockpit for those that are not going to build the windscreen and canopy option. Don't skip the next chapter if you are going to build that option however. I'm only going to cover the major assembly step once.

The Do it Yourself Cockpit Project – Series One

Chapter Twelve - Assembling the Cockpit



The Do it Yourself Cockpit Project – Series One

Assembling the cockpit out of the sub-components is very easy. Everything bolts together and providing you've been careful during the build, the parts should line up correctly. The sides may deform during construction, but as you assemble the cockpit, any deformation can be pulled straight quite easily.

First off, collect up all the bits you've built:



You're going to start off by attaching the sides to the center core. If you've got a friend that can help you with this, the task will be much easier and you won't accidentally damage a side while bolting it together.

The Do it Yourself Cockpit Project – Series One

Each side requires 5 3.5" long 1/4" bolts.



As you can see here, I'm supporting the outside edge of the side with a chair. Silly, but it works if you're by yourself. I still recommend getting a friend to help. Remember back when you pre-drilled those holes? This is where that becomes critical. Make sure all your holes line up properly before you start tightening things down.



The Do it Yourself Cockpit Project – Series One



Now lay down a blanket of some kind to protect the cockpit side, and roll it over to install the other side. Please pay careful attention to how the floor lines up with respect to height and end-to-end alignment.



You want to avoid leaning on the sides until the end caps are installed. As a complete structure, the sides are very strong, but there's enough leverage there that you can do damage if you lean on them without end support.

The Do it Yourself Cockpit Project – Series One

Install the end caps. Each one uses 12 1" long, 1/4" flat head screws:



You'll need three arms or a friend to help with this. Alternately, you can cheat by using a clamp to hold one side on while you thread screws into the holes on the other side.



The end caps add quite a bit of strength to the cockpit once they're installed. You'll notice ongoing stiffening of the frame as you add parts. This of course, is a Good Thing™.

The Do it Yourself Cockpit Project – Series One

Next you're going to install the aft cockpit arch. The first thing I want you to do though is to drill out and install a ¼-20 t-nut in the top center holes of the arch assembly:



You'll need two 2" x ¼" flat head screws for these two places. The rest of the screws are 1" x ¼" flat heads.

The aft arch is installed using four 1" x ¼" hex head bolts:



As tempting as it is, do NOT use the arch as a "handle" to move the cockpit around. By itself the mounting isn't strong enough to handle the stress. You'll just tear off the arch, leaving the two bottom stringers bolted into place. Trust me on this.

The Do it Yourself Cockpit Project – Series One

Here is the arch installed:



Now you're going to install the instrument panel support arch:



This part is installed using four 1" x 1/4" hex head bolts. If you have any bow-in or bow-out of the cockpit sides, they'll become immediately apparent at this point. Don't worry about it though – the instrument panel support arch will help correct any issue here.

The Do it Yourself Cockpit Project – Series One

Next up is the forward turtle deck:



Like the instrument panel arch, this assembly will help correct any deformation issues in the side sections. You'll use four 1" x 1/4"-20 hex head bolts to install this part.

Now install the forward turtle deck end cap:



You'll need 10 1" x 1/4"-20 flat head screws for this.

The Do it Yourself Cockpit Project – Series One

Okay, now you need to install the front and back caps on the aft cockpit arch:



This takes 10 1" ¼"-20 flat head screws and one 2" x ¼"-20 flat head screw.

The Do it Yourself Cockpit Project – Series One



The back face of the arch requires 15 1" x 1/4" flat head screws and one 2" x 1/4" flat head screw. Once this is attached, you can use the aft arch to move the cockpit around without worrying about it coming off. ☺

The Do it Yourself Cockpit Project – Series One

Last on the list is the instrument panel!



If you're not planning on building the windscreen & canopy, you're done with the rough construction of your cockpit. How you finish it is up to you and I would really like to have pictures of your project as you work on it! Work In Progress pictures and support questions can be posted to the DIY Cockpit Forum at <http://www.simpits.org/forum>.

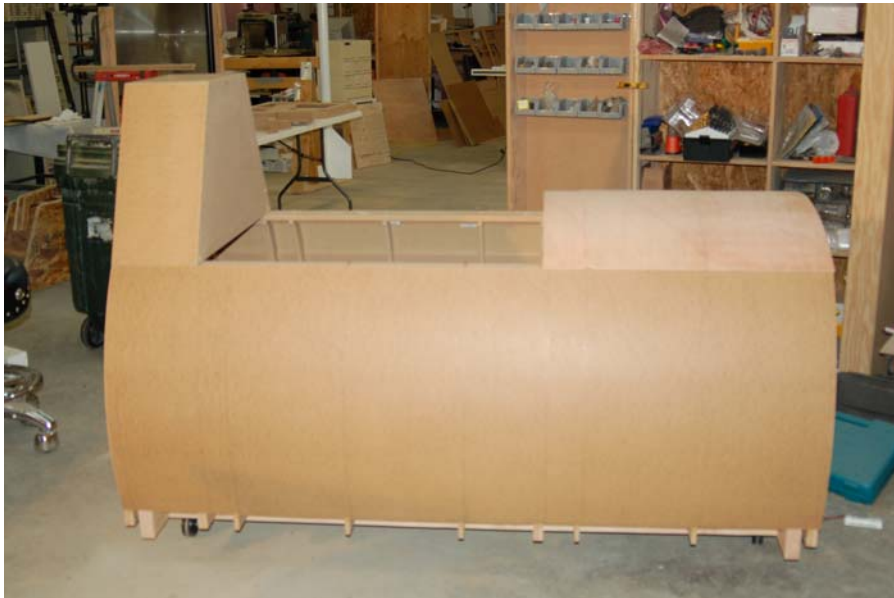

The Do it Yourself Cockpit Project – Series One

Chapter Thirteen - Building the Monitor Support Deck

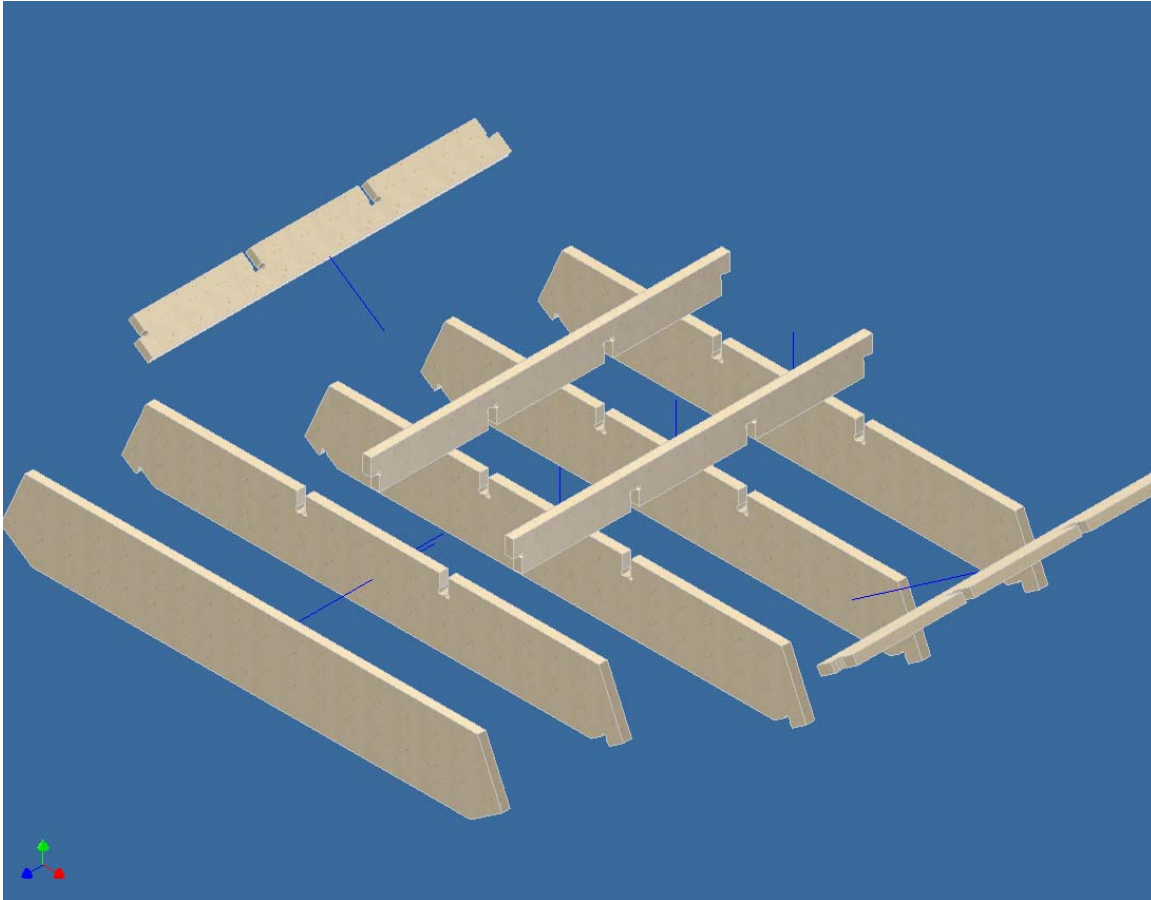

The Do it Yourself Cockpit Project – Series One

For this assembly, you're going to need the following materials:

Qty	Description
4	Part #29 – Monitor Deck Rib
4	Part #28 – Monitor Deck Stringer
1	Part #30 – Monitor Deck Face

The Monitor Deck is used on the DIY cockpit to either support a standard monitor or the bottom edge of a projection screen.

The assembly will go together quickly and is pretty much self-aligning as long as you're careful.

The parts...



As you can see this is pretty simple to build. It's almost like assembling Ikea furniture. You're going to want to dry fit the parts to make sure they go fit properly. The monitor deck parts use notches that are a bit larger and won't require you to widen them a bit like the other MDF parts. If you're using OSB, the parts will be just a little loose, so please be careful in how they align.

The Do it Yourself Cockpit Project – Series One

The first step is to assemble the “core” of the deck using two ribs and two stringers like so:

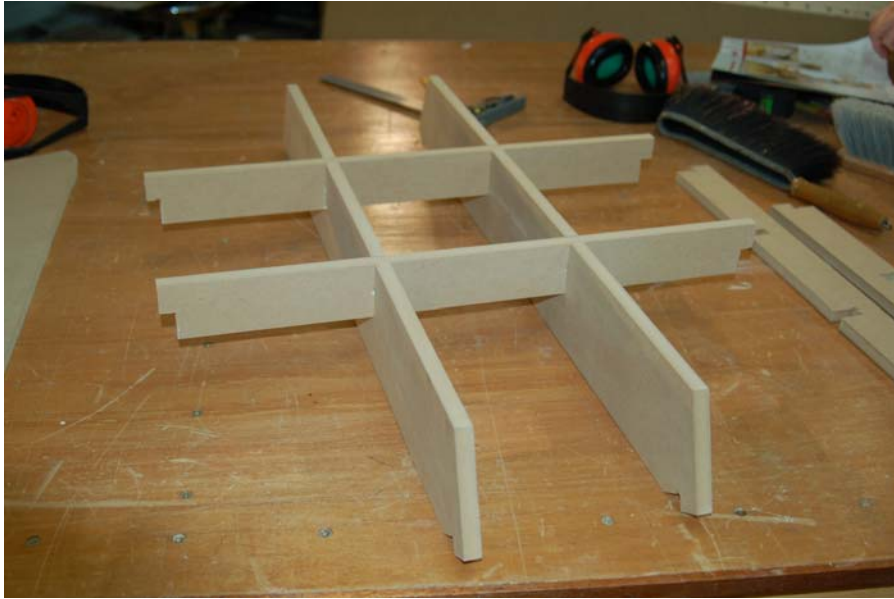

There shouldn't be any need to use pins here, but you can if you like. Just make sure that you're using glue on all the flat surfaces in the notches on all the parts.

Next, you're going to add the outside ribs:

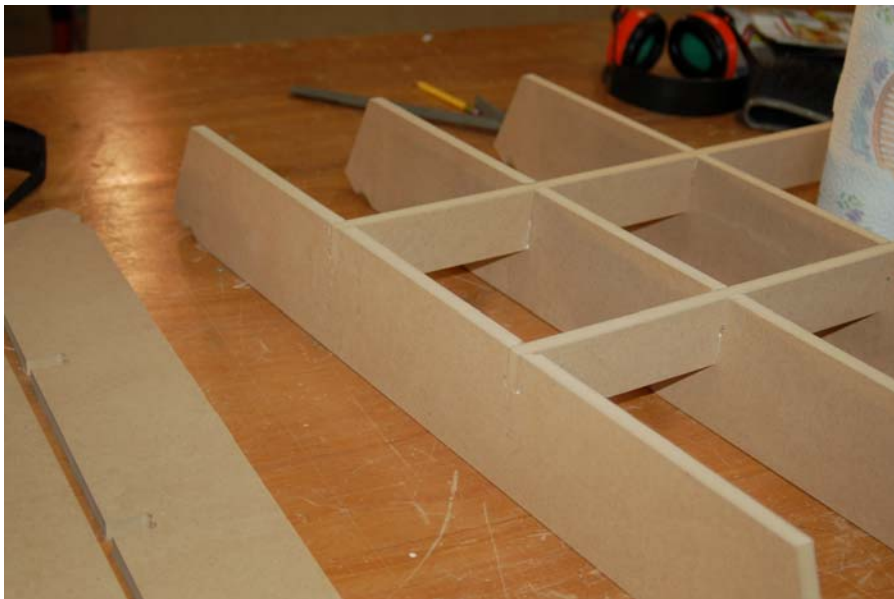

You'll want to use two pins on the ends to help reinforce the glue joint.

The Do it Yourself Cockpit Project – Series One

Now add the last two stringers to the sides of the deck assembly:

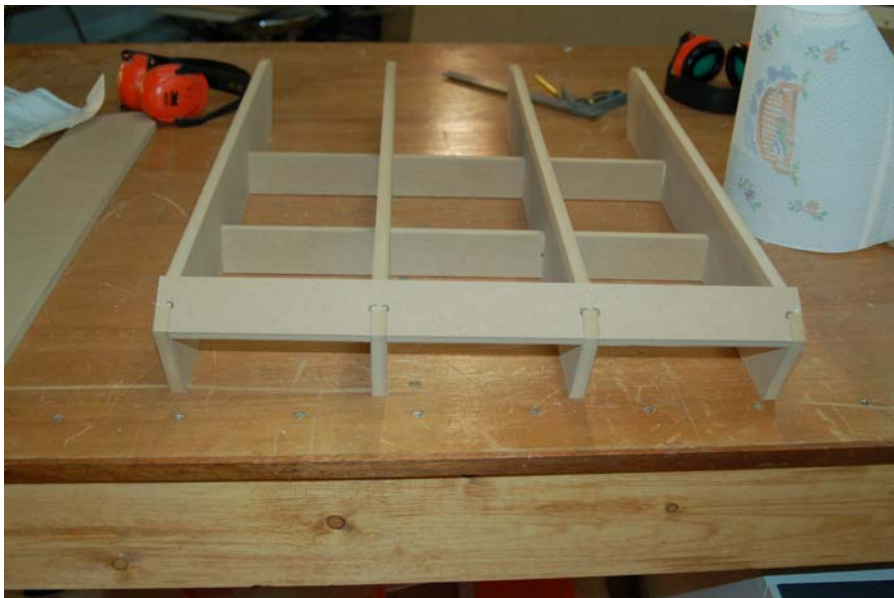
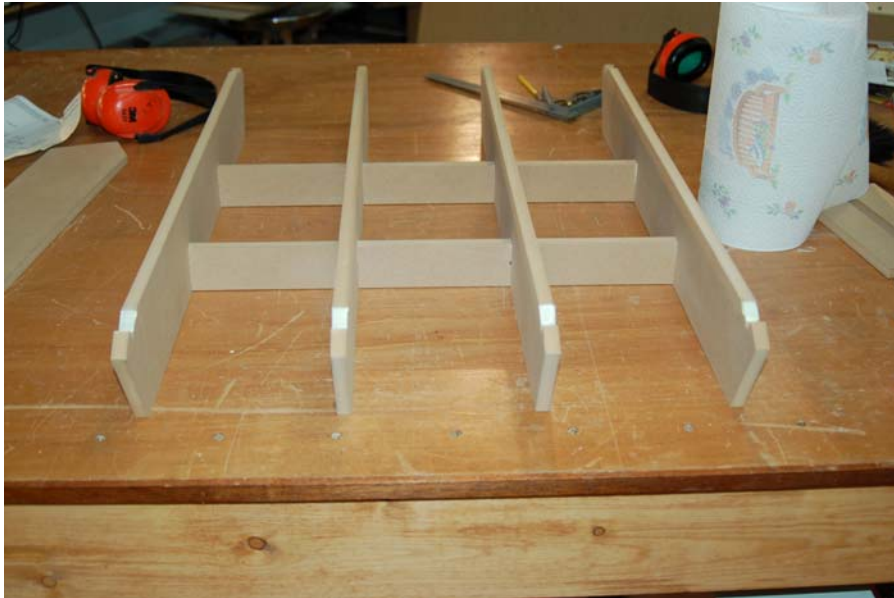

Make sure to use two pins on each rib when attaching this stringer – glue is required as well! Be very careful to ensure that before you start firing pins into this that you’ve got the stringers square to on another. If this is built “racked”, it will not fit the cockpit shell properly! The easiest way to check for this is to measure the top of the assembled monitor deck diagonally in an “X” pattern. You should end up with the same measurement for both “arms” of the “X”.

The Do it Yourself Cockpit Project – Series One

The last step before it gets skinned is to add the “face” of the monitor deck. This is the component that the hinges will attach to later. You want to take the deck assembly and flip it upside down like this:



As you can see, the deck face has already had glue applied. You want to position the deck face so that its bottom edges are perfectly in line with the monitor deck itself. Pin and clamp into place.

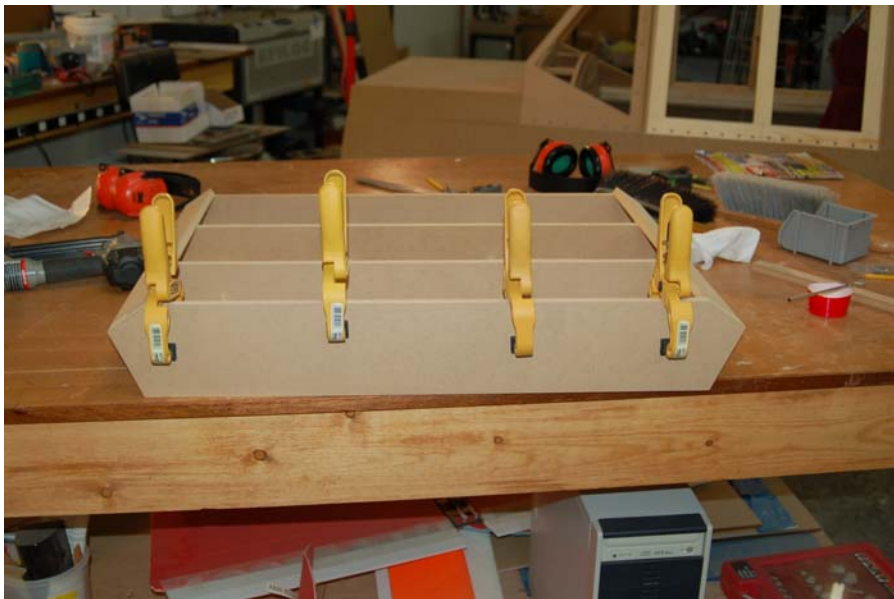

The Do it Yourself Cockpit Project – Series One

Now whoever said you can use too many clamps....may have been on to something...



Seriously though, you do want to make sure that the face is clamped into place as well as possible.

Next, you're going to cut the top skin. This consists of a 21-3/4" x 26-3/4" sheet of 1/8" hardboard that's had 24 degree bevels cut along the short (21-3/4") axis. Go ahead and cut that out and then whip out your handy angle gauge...

Now you need to set up your table saw to cut the bevels on the top 1/8" skin.

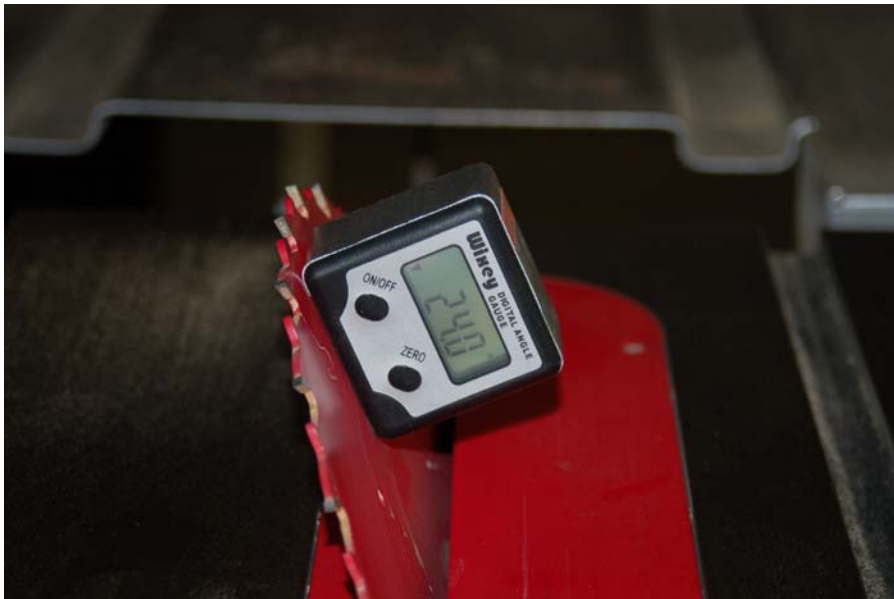

The Do it Yourself Cockpit Project – Series One

Set your fence width for 26-3/4" like so:



To make sure you're setting the distance correctly, make sure the highest point of the blade is even with the top surface of the material you're cutting. Measure from the fence to that point. This will ensure that you're not accidentally cutting the sheet short.

When you're done, the sheet should fit like this:



Set the top sheet to the side as we need to make and install the edge reinforcement stringers.

The Do it Yourself Cockpit Project – Series One

Using scrap stringer material, I want you to cut lengths of it at 24 degrees, just like you did for the top skin. Take the minimum amount off them to get the full bevel. These are going to be cut down in length and inserted between each of the ribs that make up the monitor deck.



Cut these as accurately as you can. They're going to be glued into place and the fit must be snug, but not so tight that it distorts the framework. Grab a pair of long clamps and start gluing!

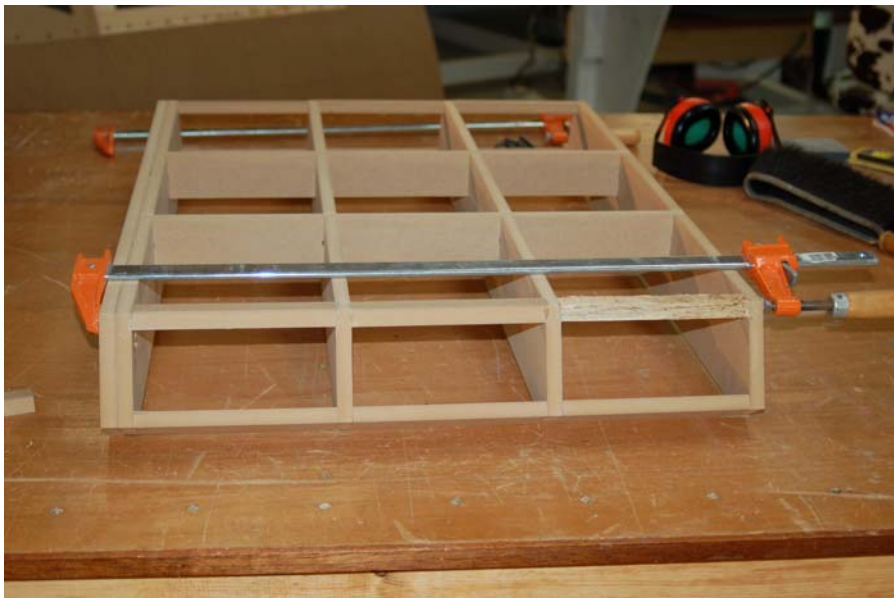

The Do it Yourself Cockpit Project – Series One

Set the monitor deck aside and let it dry. You don't want to be firing 18ga brads into it until the glue has had time to be of some use.

After letting it dry, draw light pencil lines along the cross-hatch pattern made by the framing. You'll use these to know where to fire the pins after the sheet has been applied to the framework.

Apply glue to all the areas that support the top and nail it down:



Next you'll need to cut two 3-3/4" wide by 21-3/4" long sheets of 1/8" hardboard for the sides:



The Do it Yourself Cockpit Project – Series One

Glue and nail the sides down just as you did the top skin.



You can take the top edge of the side skin off with some 60 grit sandpaper and follow it up with 220 to smooth it out. Set the monitor deck aside for now. You're done with it until the final assembly steps.

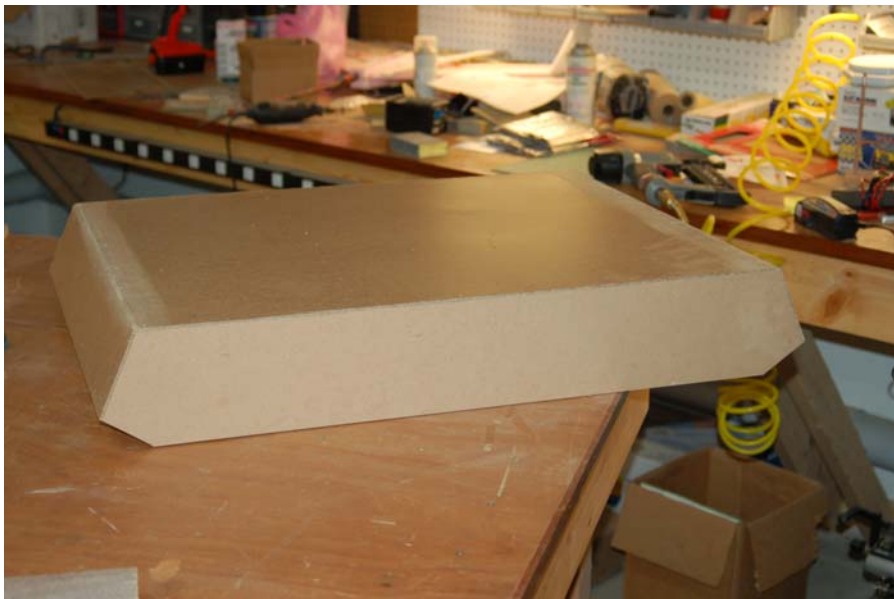

The Do it Yourself Cockpit Project – Series One
Chapter Fourteen - Building the Windscreen

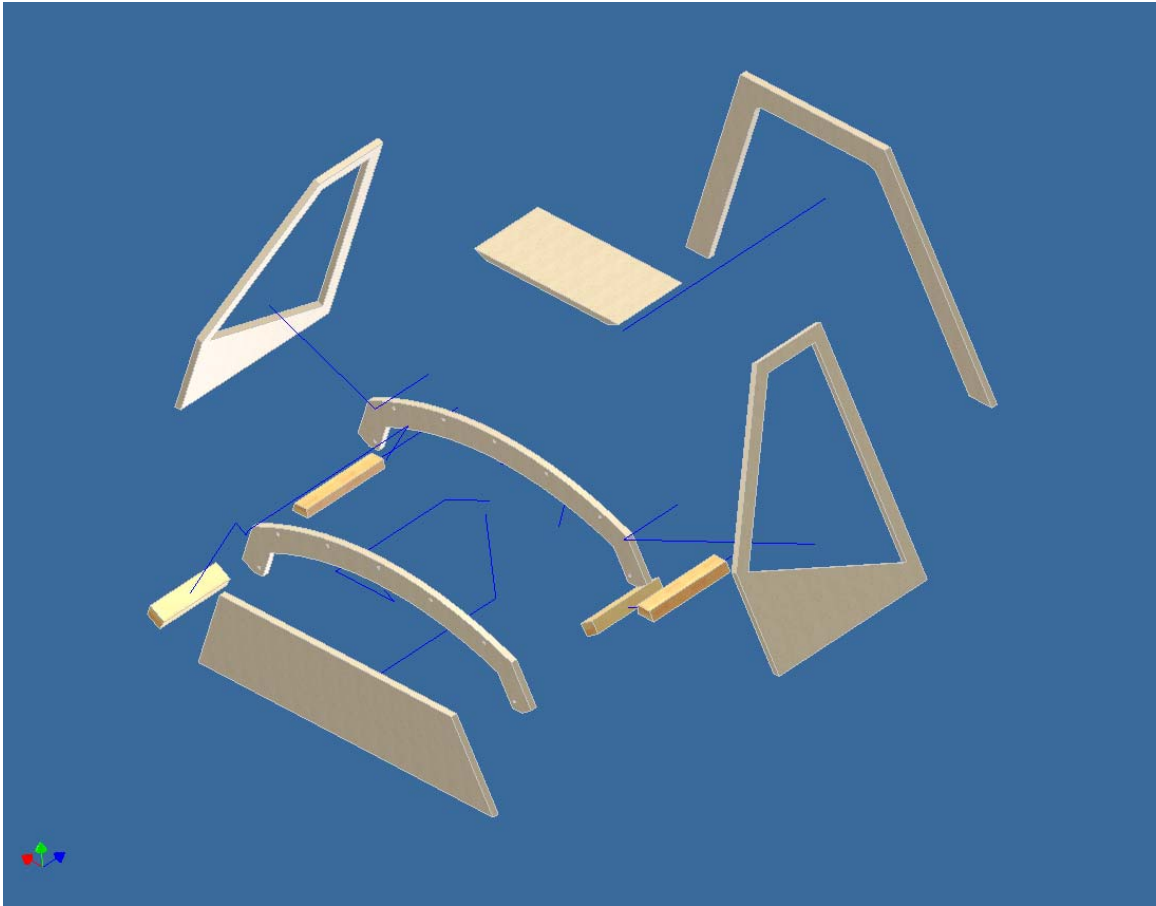

The Do it Yourself Cockpit Project – Series One

For this assembly, you're going to need the following materials:

Qty	Description
1	Part #24 – Windscreen Face Frame
2	Windscreen Face Frame Reinforcement Block (spec. detailed below)
2	Side Frame Reinforcement Block (spec. detailed below)
1	Part #20/L – Windscreen Side Frame, Left
1	Part #20/R – Windscreen Side Frame, Right
1	Part #22 – Windscreen Top Frame
1	Part #21 – Windscreen Lower Frame
2	Part #15 – Instrument Panel Support Arch
1	Part #26 or #27 – Instrument Panel

The first thing you need to do for this is to get all the required angle cuts made on the various parts. We're going to start with the 23.5 degree cuts along the base of the windscreen side frames. This will give us the left & right sides that are listed in the parts list above.

Set your table saw up for a 23.5 degree cut. Since your parts may vary a bit from mine, measure along the long edge of the windscreen side frame to get the figure to set your table saw fence. Mine happened to come out at 19 19/32", which is within the error tolerance for the part. To ensure that you're cutting them properly, cut the right side like this:

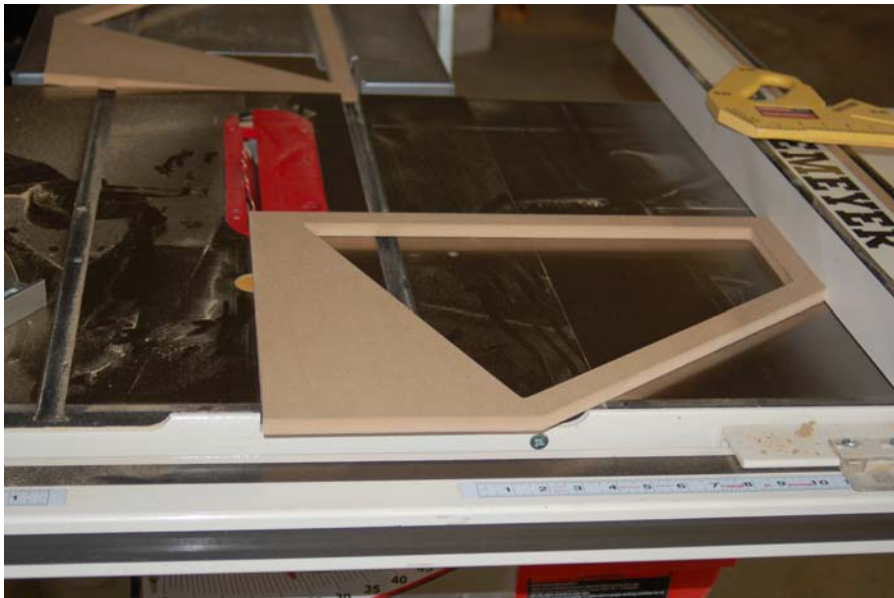

The Do it Yourself Cockpit Project – Series One

Then cut the left side like this:

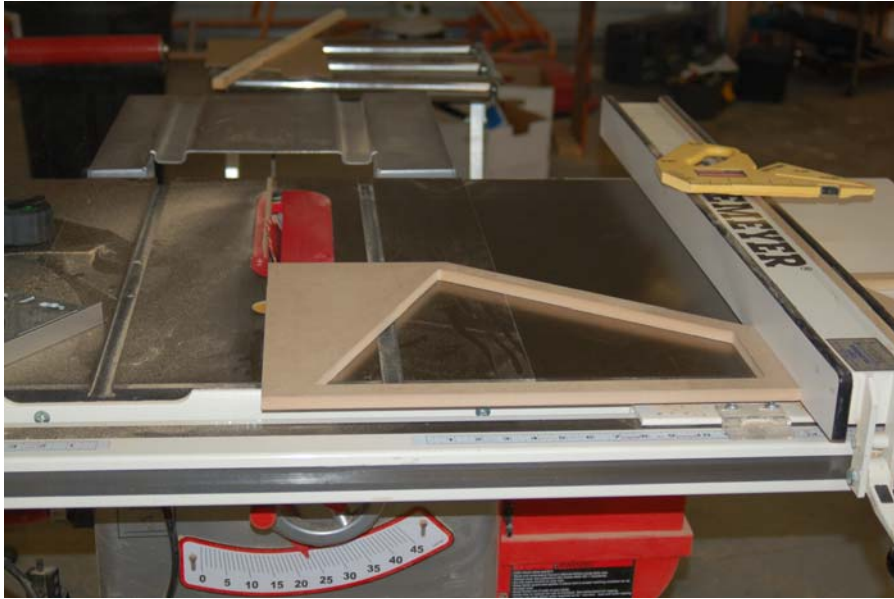

This should leave you with the parts looking like this when stacked:

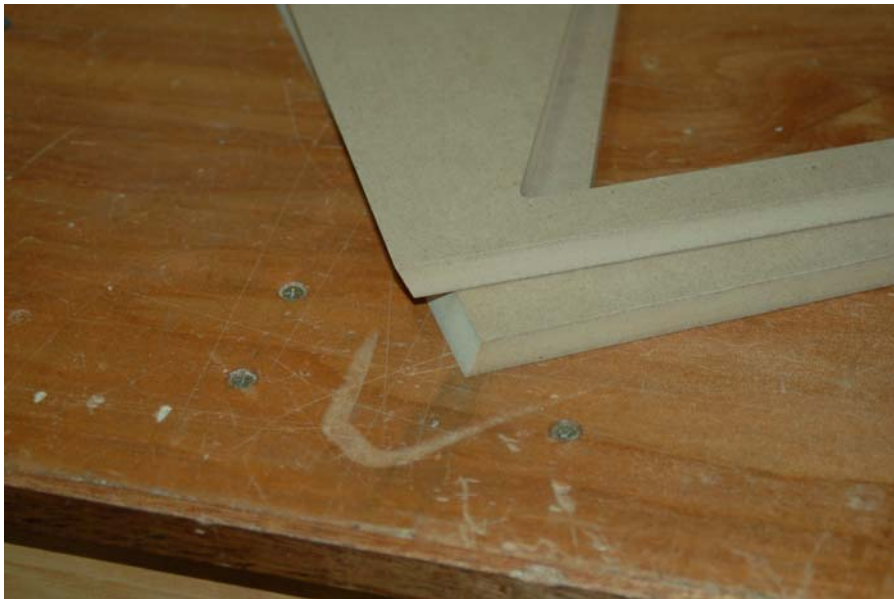

In order to make the two windscreen face frame reinforcement blocks, you'll need to rip down some $\frac{3}{4}$ " pine to 1.5 and cut a 23.5 degree bevel in it as shown on the next page. These parts are 7-1/4" long.

The Do it Yourself Cockpit Project – Series One

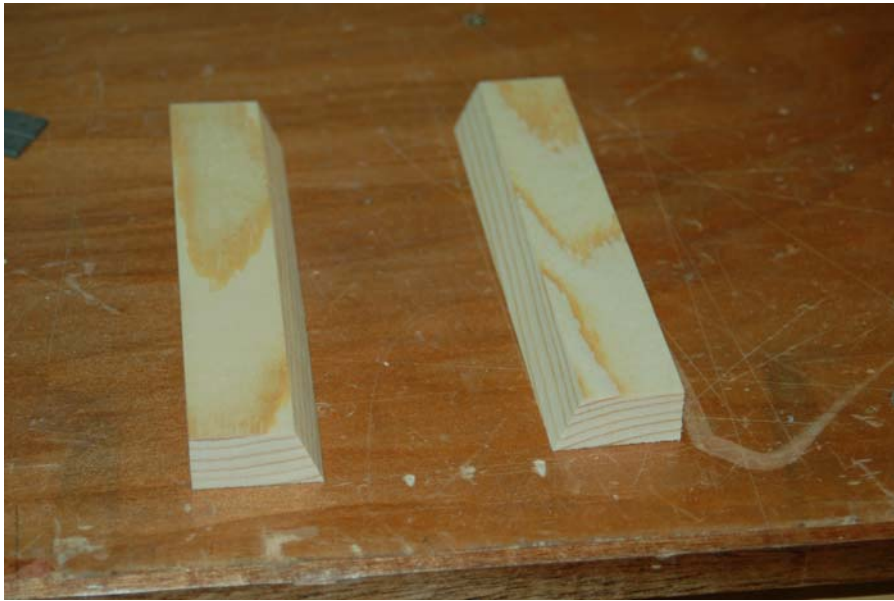

Next, you'll need to rip down a 6" length of 2x4 so you end up with two 1" x 1-1/2" blocks, 6" long. Bevel cut them at 9.5 degrees as shown below:

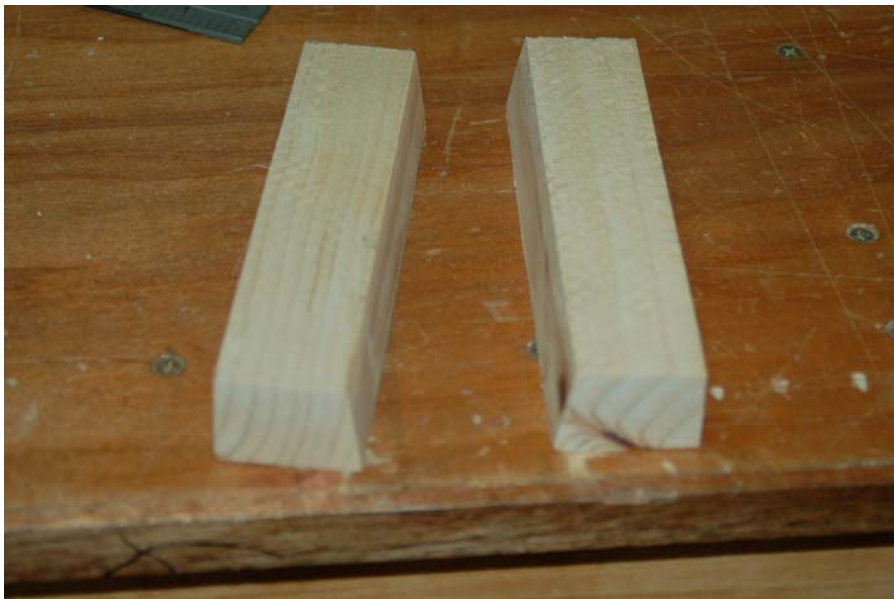

These two blocks are the side frame reinforcement blocks as listed at the beginning of the chapter.

The next part cuts you need to make are simple – you'll need to rip down some 3/4" Pine into 3/4" strips. You need two 17" lengths and two 4-1/2" lengths. These are used as the attachment points for screwing the face frame to the side and top windscreen frames.

The Do it Yourself Cockpit Project – Series One

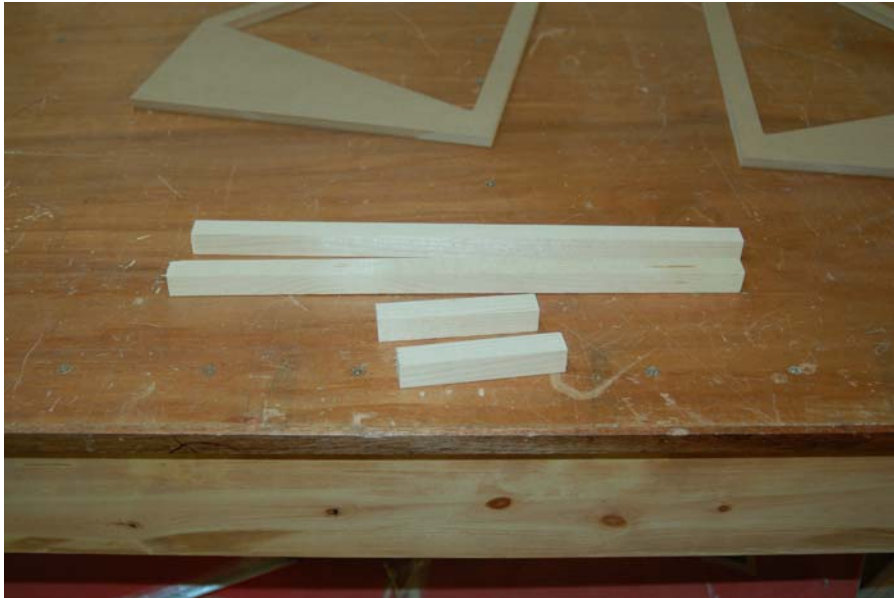

$\frac{3}{4}$ " x $\frac{3}{4}$ " Pine reinforcement strips

This last step in pre-cutting parts is the most “tricky” for those that have never done it before, so please pay careful attention.

First, set your saw for a 23.5 degree bevel cut and then set the blade height to $\frac{1}{2}$ ":

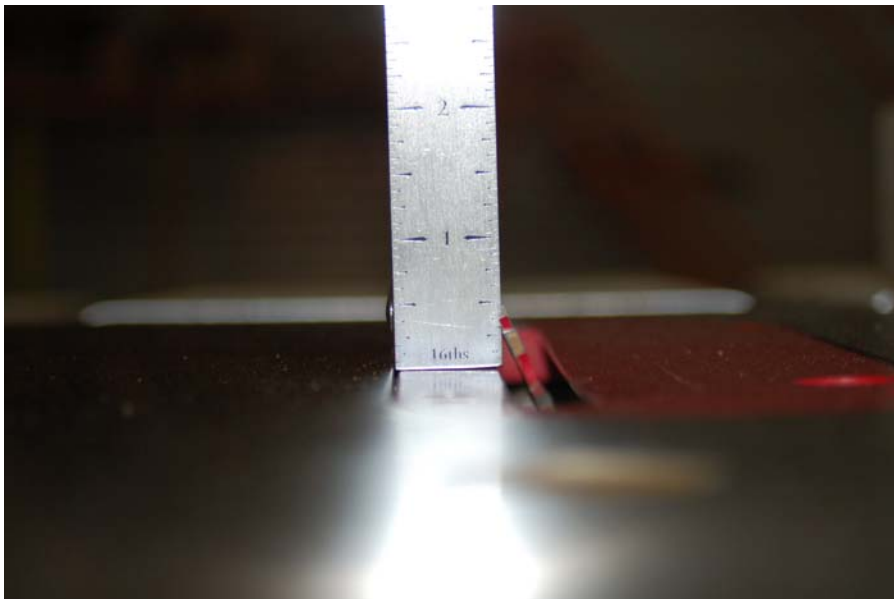

The ruler in the picture isn't exact – I had to use a magnet to hold it in place while I took the photo, but trust me, the blade height is set to $\frac{1}{2}$ ".

The Do it Yourself Cockpit Project – Series One

The gadget shown below is called a “Tenon Jig” and is designed to do just the kind of thing you’ll be doing in a second. If you don’t have a tenon jig, they are very easy to make and a quick search on the net will show you plans for a number of them. If you’d like to buy one instead of build one yourself, Rockler (<http://www.rockler.com>) has a very nice heavy duty tenon jig for about \$80.



I want you to adjust the fence (or the stand alone tenon jig if you have one of those) so that the blade is just barely not in contact with the jig face.



The Do it Yourself Cockpit Project – Series One

I do this by spinning the blade with my thumb (wear a glove!) as I tap the jig closer. When the blade just starts to “tick” the jig, I tap it back the other way just a tiny bit so the blade no longer touches the jig.

Here’s another photo that illustrates the point from a bit of a different angle:



Now clamp the windscreen top frame (yes, I know it’s not really a “frame”) into the tenon jig. Make sure that the bottom edge of the frame is in contact with the table saw surface:



Now start up the saw and *carefully* send the part through. When you get to the other side of the blade, stop. Don’t draw the part back through as you might normally.

The Do it Yourself Cockpit Project – Series One

Turn your table saw off and slide the jig back. Take the frame out of the jig and flip it around. The cut you just made should look like this – the image also shows the orientation of the cut when the frame is put back into the jig for the second cut.



The result of the first cut.

Now run the jig through the saw again to make the second cut. Now that those two cuts are made, there are two more needed to finish the part.

Leave your saw configured as it was for the first two cuts, but adjust the blade height and fence depth so it looks like this:

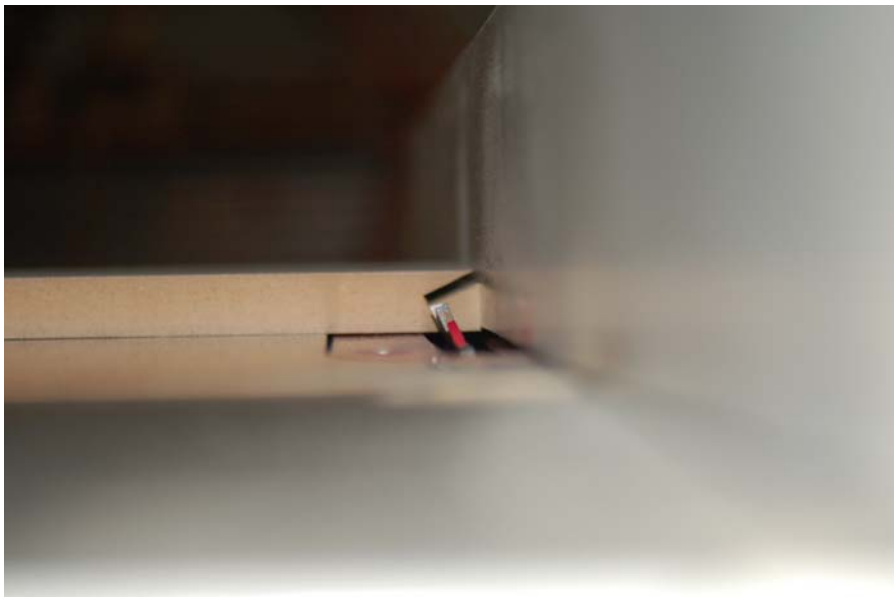

The Do it Yourself Cockpit Project – Series One

You want the blade height set so that it just takes off that little ledge of material. You do NOT want to cut any deeper or you'll screw up the part fit! When both sides are cut, you'll have something that looks like the image shown below.



Now we start putting this whole thing together. First off, let's assemble the two halves of the windscreen face frame:

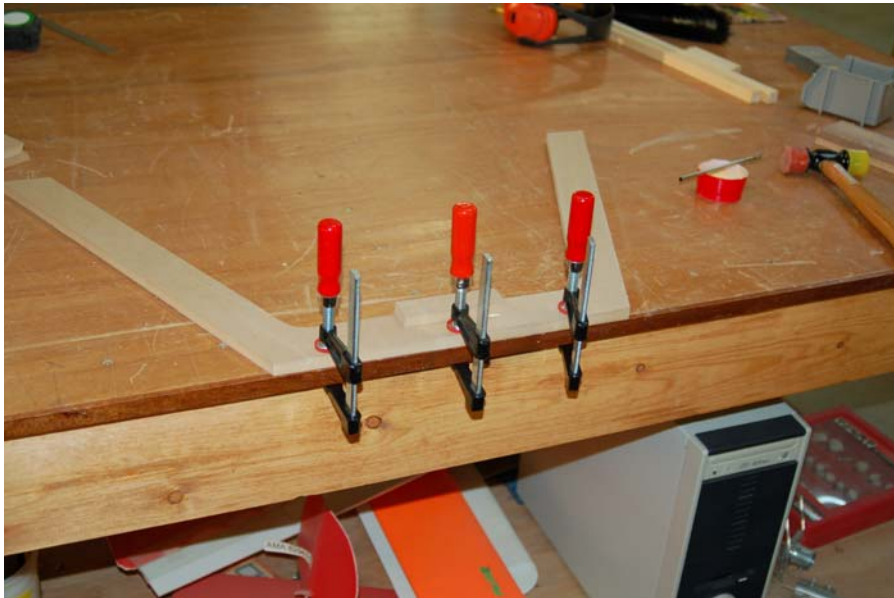

You butt the two frame halves together as shown above and then install a 4" x 1" wide piece of stringer scrap with 18ga brads. Make sure you apply glue to both the butt joint of the face frames as well as to the 4" reinforcement strip. Please make sure that the butt joint is as tight as possible. This component dictates the final width of the windscreen, so it's got to be as close to perfect as you can make it.

The Do it Yourself Cockpit Project – Series One

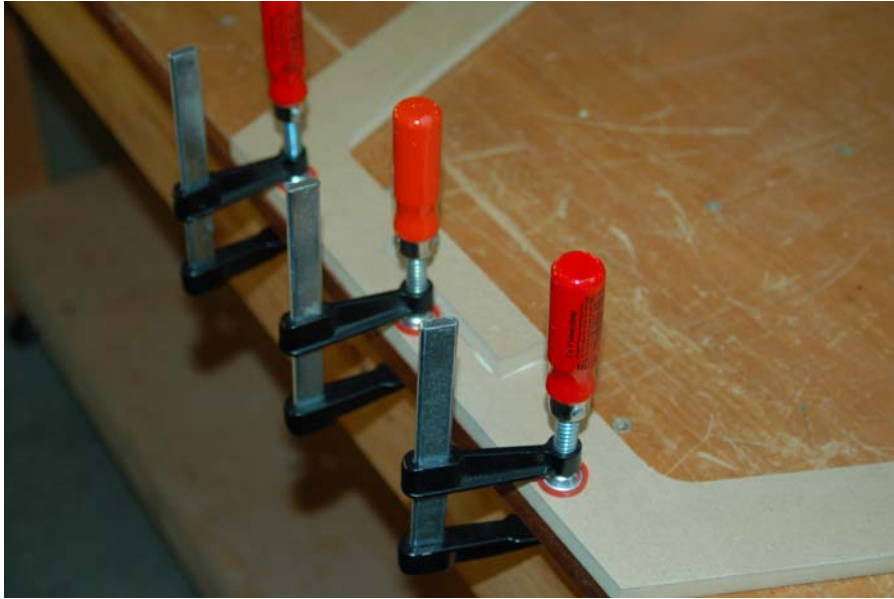

This is a bit better picture that illustrates how the face frames go together. Do NOT move these parts until the glue is dry! Until it's attached to the rest of the windscreen frame, this part is very weak and must be handled with care. I recommend pinning it from the opposite side as well once the glue dries. Use $\frac{3}{4}$ " brads to keep them from penetrating too far and coming out the other side of the frame.

The first step in the windscreen assembly is to draw a line $\frac{7}{8}$ " from the edge around the perimeter of the frame like so:



The Do it Yourself Cockpit Project – Series One

I know that the lines are hard to see, so if you need to see them, you can check out the image called “windscreen assembly 1.png” on the CD.

Starting at the bottom of the windscreen frame, make a pencil mark a 1-3/4” from the base, then 5 more marks at 3” intervals starting at the mark you just made. Make sure you mark both “arms” of the windscreen frame.



Next, make a mark 1” in from where the horizontal line intersects the vertical line. (see pic above). From that mark, make another 2-9/16” from the mark at 1”. Do the same thing on the opposite side of the frame.

The Do it Yourself Cockpit Project – Series One

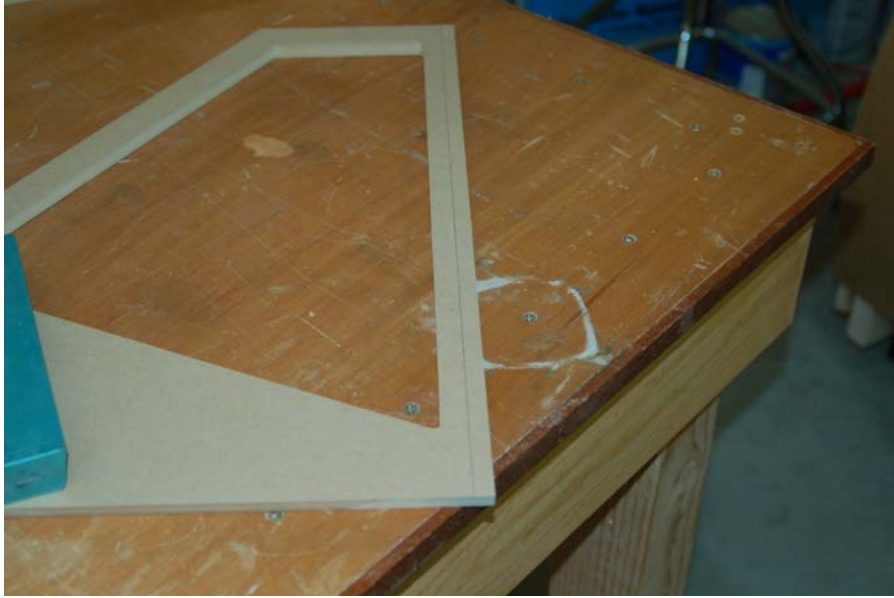

Using the image above as a guide, draw another line $\frac{3}{8}$ " in from the edge. Mark along the line the same way you did on the two "arms" of the windscreen frame. Make the first at $1\text{-}\frac{3}{4}$ " and then 5 more at 3" intervals.



Now it's time to start assembling all these parts into something recognizable as a windscreen...

The Do it Yourself Cockpit Project – Series One

Take the right windscreen side frame and apply glue all along the edge that mates to the windscreen face frame. Clamp it together like so:

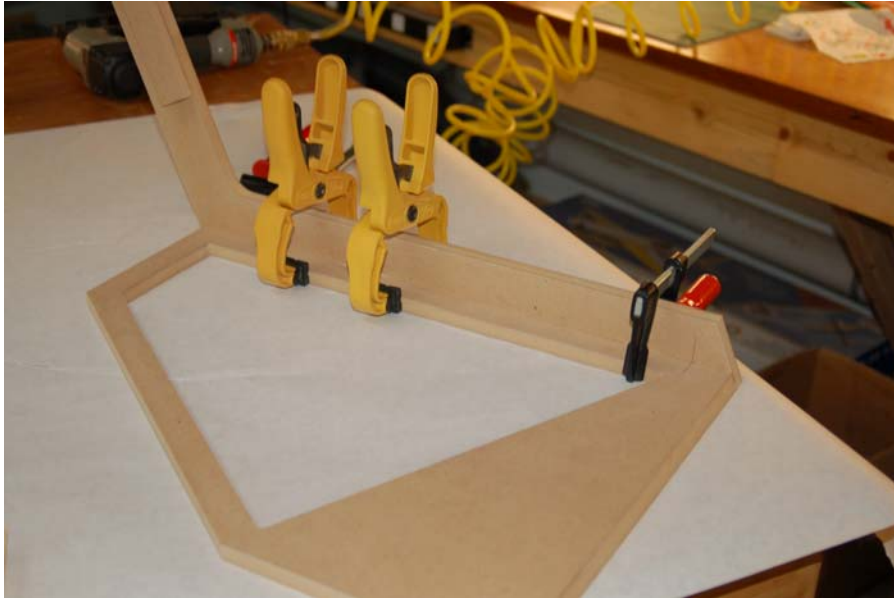

You need to take special care to make sure that the bottom edges line up perfectly. If they don't you're going to have an alignment problem later on. You want to space the clamps in such a way that you'll be able to reach some of the pencil marks with a drill and countersink:

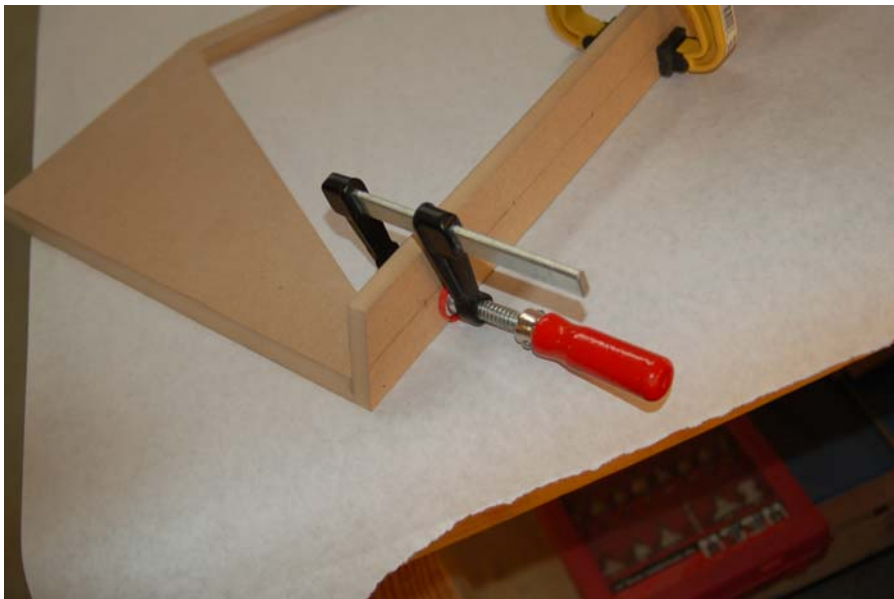

The Do it Yourself Cockpit Project – Series One

Now place the windscreen face frame reinforcement block into place and mark where it intrudes into the space where the screw plate will occupy:

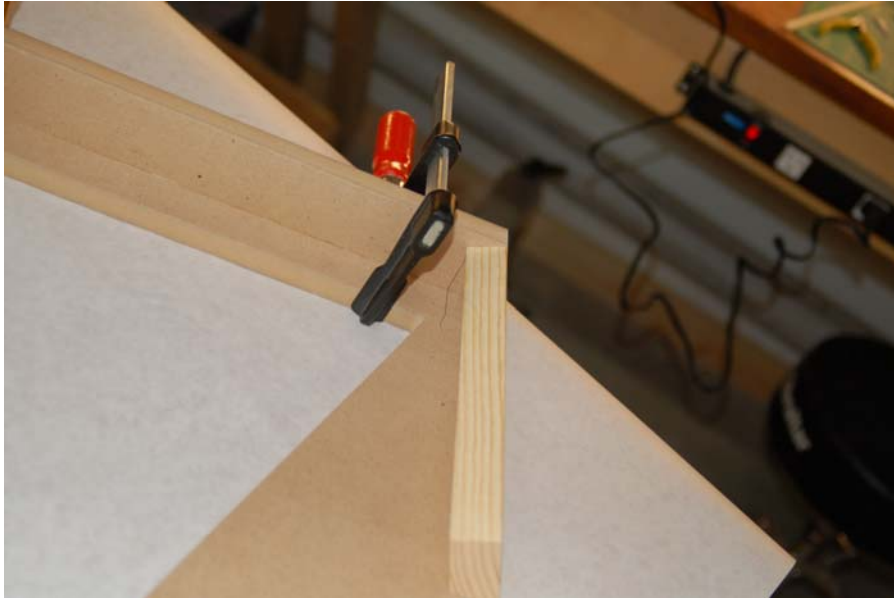

Take one of the two 17" long screw blocks and apply glue to the two adjacent faces that will fit into the corner of the windscreen side frame and the windscreen face frame as shown:



The Do it Yourself Cockpit Project – Series One

Clamp it into place from at least two points to ensure that it's held tightly into the corner. Now you want to start drilling $7/64$ " pilot holes for the #8 1-1/4" screws that you'll use to screw the frames together:

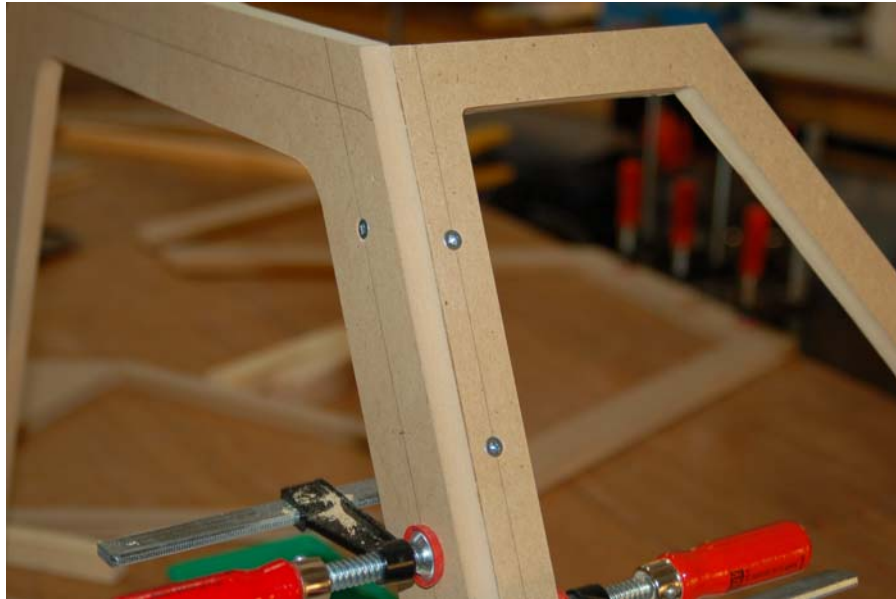

Remove the clamps as you go and when you're done, the right side should look like this:

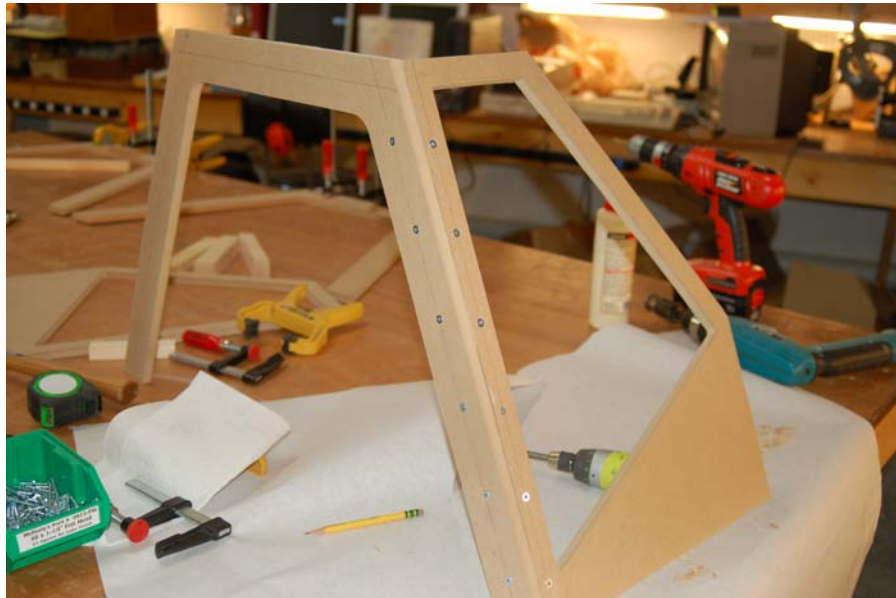

The Do it Yourself Cockpit Project – Series One

Now repeat this process for the left side. Working with the other side can be a bit tricky – you don't want to put a lot of stress on the butt joint that holds the windscreen face frame together. What I did was to lay the frame face down and work on it with the edge of table as you can see below:



Here's another image to help illustrate how it goes:

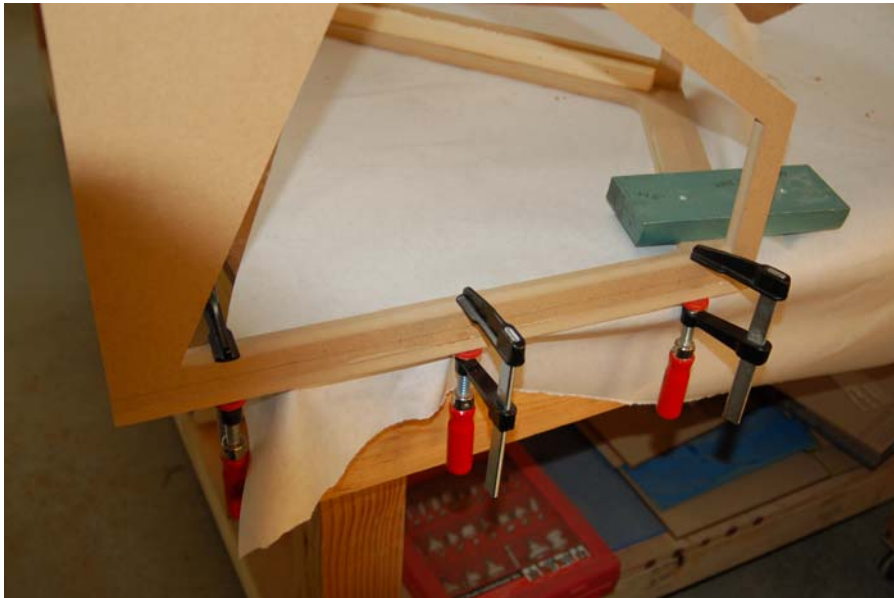

The Do it Yourself Cockpit Project – Series One

When you're done assembling the other side, you should have a framework that looks like this:

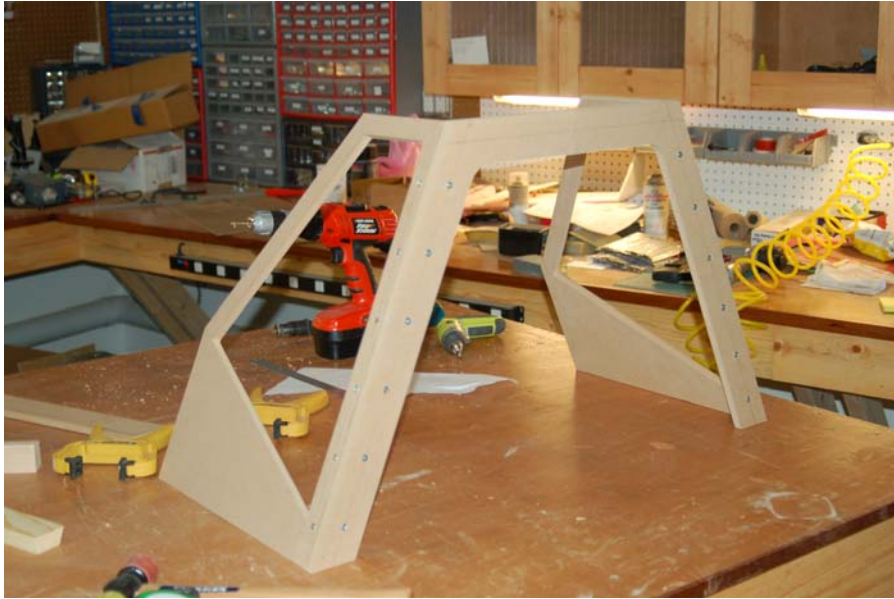

Now you need to install the windscreen top frame – this is very easy to do and “self-aligns” because of how it was cut. Just lay the windscreen frame face down and slide the part into place after applying glue to the contact edges:



The Do it Yourself Cockpit Project – Series One

Install the two 4-1/2” screw blocks as shown below – don’t forget to apply glue to the two edges that meet the windscreen face frame and the windscreen top frame:



Now drill and countersink at the marks you put on the face frame:



The Do it Yourself Cockpit Project – Series One

Next, pilot drill and countersink for four screws along the face edge of the top windscreen frame:

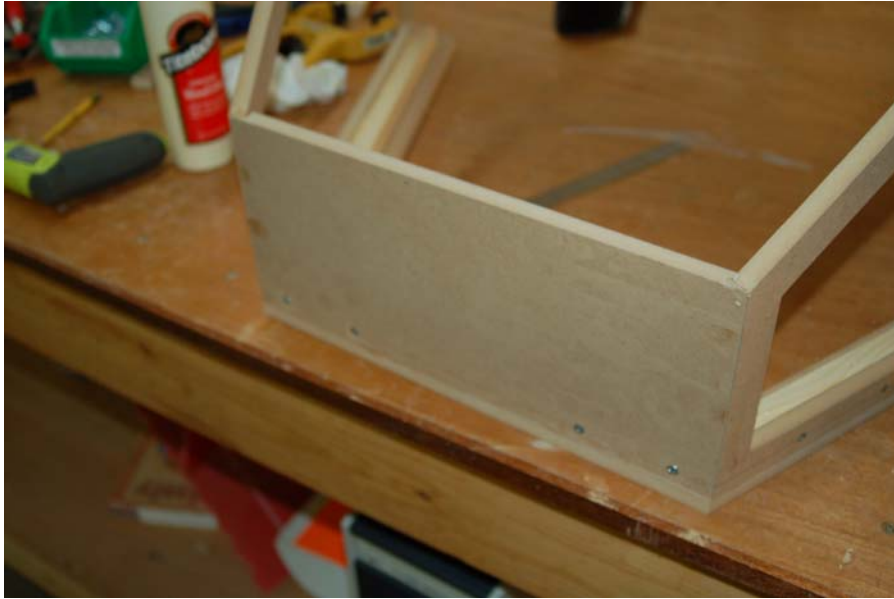

The centerline for the screws will be about 7/8" as measured from the outside face of the windscreen face frame.

Now it's time to install the lower face frame! This one is very easy. Just apply glue to the edges of the part, put in place and pin it into place using four brads on each side:



The Do it Yourself Cockpit Project – Series One

At this point, the windscreen frame should look like this:



Now you want to draw a line along the bottom edge of the windscreen side frame, 5/8" from the bottom, like so:

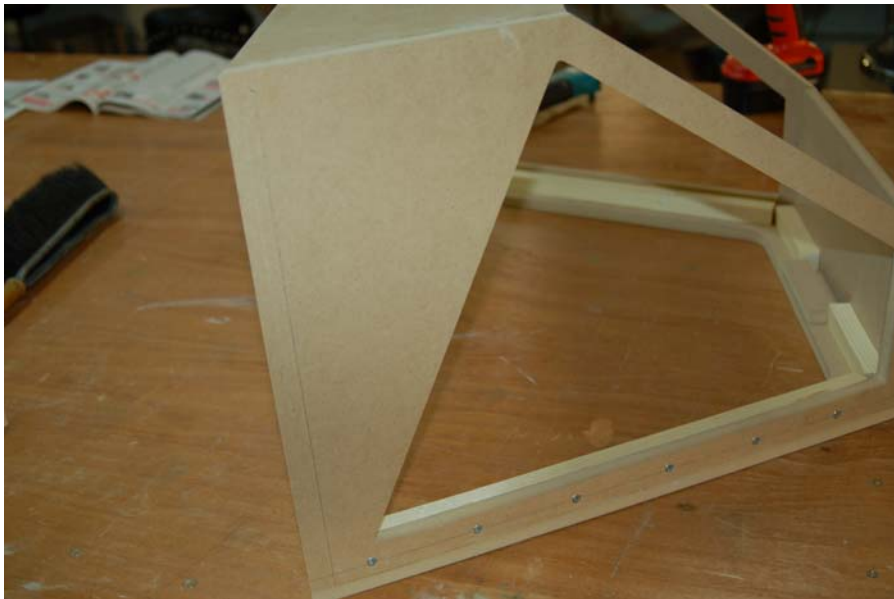

The Do it Yourself Cockpit Project – Series One

The next item up is installing the 7-1/4" windscreen face frame reinforcement blocks. Measure in 1" from where the two perpendicular lines cross and make a mark. Make four more marks spaced 1-1/2" apart as shown:

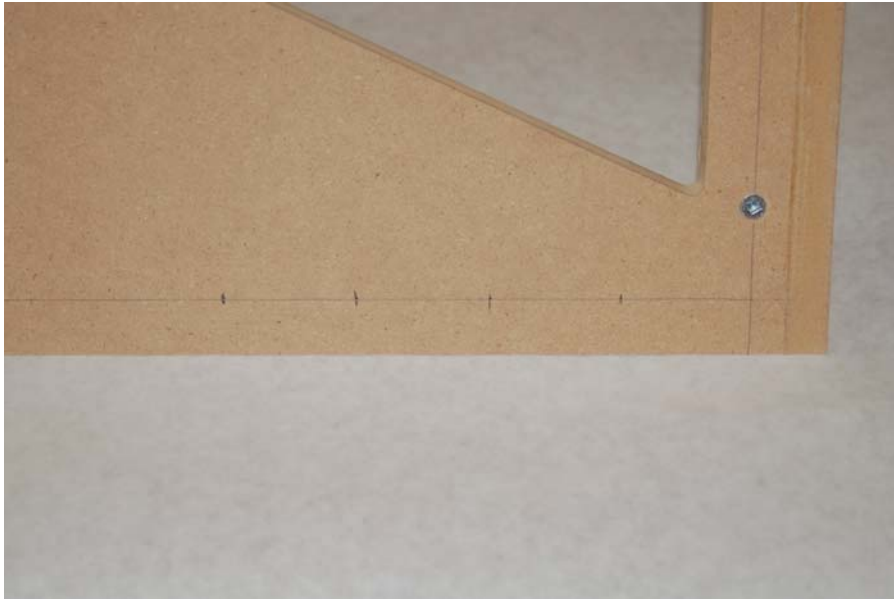

Apply glue to the reinforcement block and place it into position as shown below:

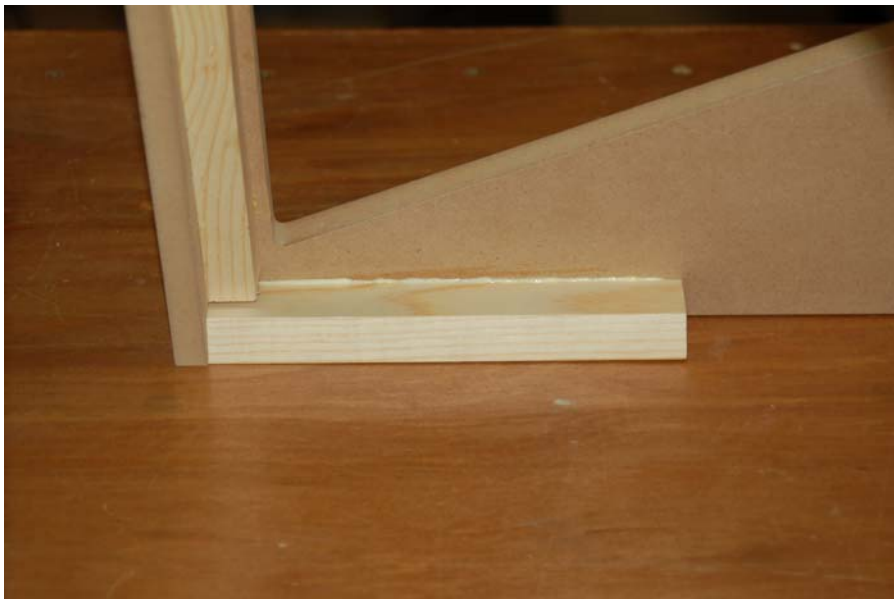

You need to drill 5 7/64" pilot holes, 1" deep at the marks you just made on the windscreen side frame. Try to keep your drill bit as perpendicular as possible with the angle of the windscreen frame surface. Countersink and install 5 1" #8 screws as pictured on the next page.

The Do it Yourself Cockpit Project – Series One

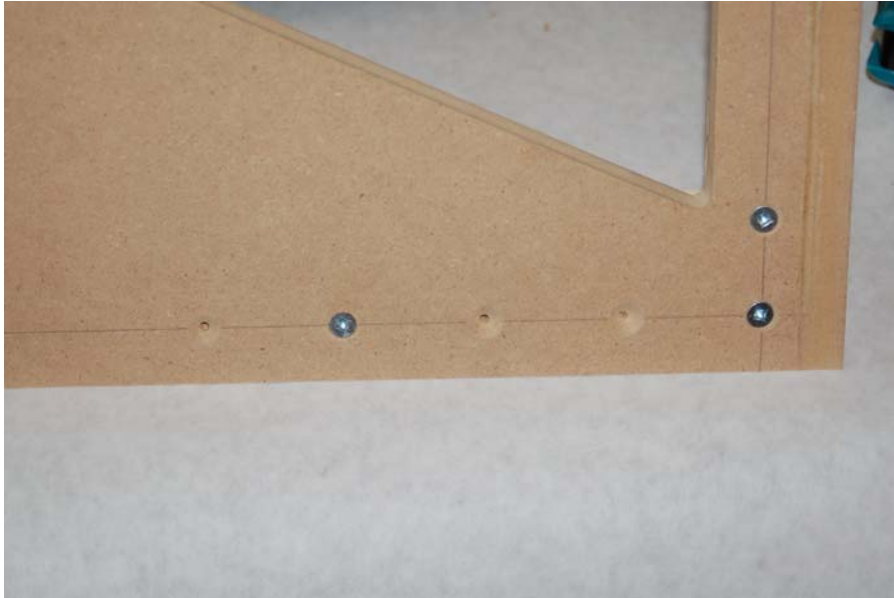

The block on the opposite side is installed the same way. (Of course! ☺)

The next step needs to be done carefully. You're going to install the two 6x1x1-1/2" windscreen side frame reinforcement blocks while the windscreen assembly is mounted to the cockpit.

First, measure 27-1/2" from the forward face of the aft cockpit arch and draw a line. Do this on both cockpit rails. These are the alignment marks that you'll use to properly position the windscreen assembly.

Here's where it gets a bit dicey – even if you've done everything right, the cockpit sides may be slightly farther apart or slightly closer together than they need to be. In my case the cockpit sides were too far apart. I used a ratcheting cargo strap to draw the sides together. You're going for somewhere in the neighborhood of 24-3/4" from rail to rail as measured from the inside of the rails. I say "somewhere" because the actual distance is going to be dictated by how well you built the windscreen. ☺

You want to position the windscreen so that the outside face of the windscreen sides are flush with the *inside surface* of the cockpit skin. To do this, you're going to need to draw the sides together, or shove 'em apart. If you need to move them apart, I suggest getting yourself a pipe clamp, reverse it and use it to spread the sides apart. This is what I needed to do on the development prototype and it worked out very well.

If you're skinning with aluminum, the side faces of the windscreen should match up perfectly with the skin – that's how it was designed. :)

The Do it Yourself Cockpit Project – Series One



Here's what I needed to do for my cockpit. When you're compressing the sides like this, make sure you do it as close to the rib just aft of where the windscreen is positioned. Whatever you do, do NOT ratchet it down quickly! You're going to break something if you're not very careful. Just take it slow and listen carefully for cracking sounds. I know that sounds ominous, but I can't stress enough how careful you need to be here. Once you have the sides compressed (or expanded!) to where the outside surface of the windscreen face is flush with the inside surface of the cockpit skin, clamp the windscreen into place using two clamps each on the windscreen face frame reinforcement blocks.

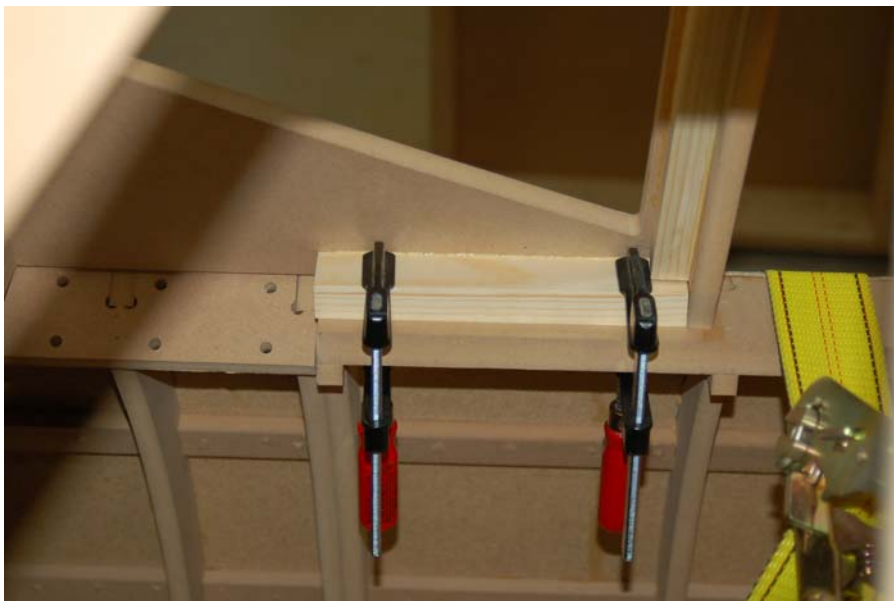

The Do it Yourself Cockpit Project – Series One

Do *not* release the cargo strap or expander clamp yet! (In fact, don't even think about it – I'll tell you when it's safe to remove it. For now, pretend it doesn't exist)

Make a mark 5/8" in from the front edge of the windscreen and then four more, 1-1/2" apart as shown below:

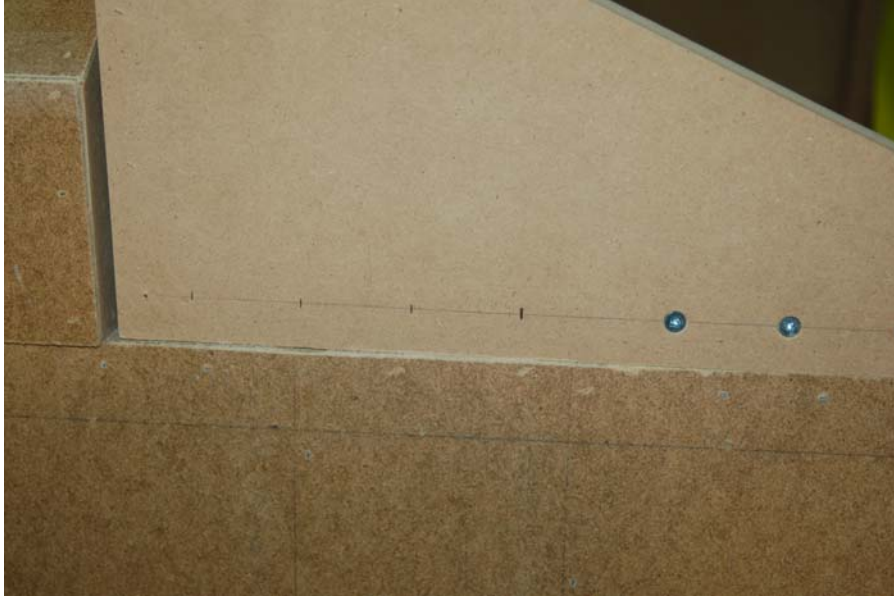

Now you need to drill two mounting holes, one on each side of the windscreen frame. You're going to need a long 1/4" drill bit to drill this hole:



Positioning of the hole is pretty "free-form". You want it along the centerline of the block, and far enough out from the edge of the windscreen frame that you can still tap a bolt into the hole. Once you have the hole drilled, install a 2" 1/4" hex head bolt using washers on both sides and a nut on the under side.

The Do it Yourself Cockpit Project – Series One



Now move to the opposite side and drill & install the other bolt there.

The Do it Yourself Cockpit Project – Series One

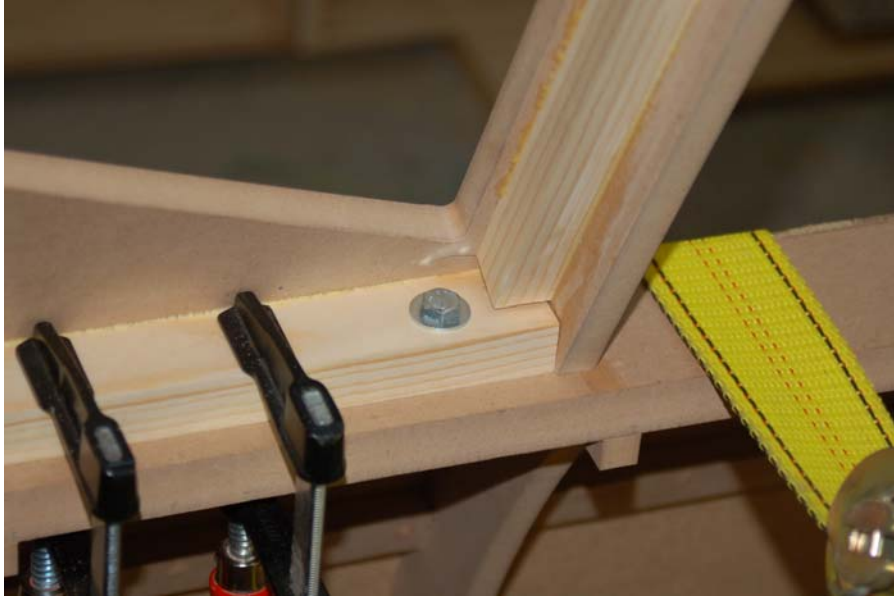

Do **NOT** remove the clamps from either side yet.

Now you need to apply glue to the side frame reinforcement block and place it into position as shown below:



The block is actually installed upside down so that when it's placed firmly against the inside surface of the windscreen frame, the bottom face of the block will mate flush against the lower cockpit framing. Drill four 7/64" pilot holes along the marks you made a short while ago and countersink them. Install four 1" #8 screws. Do this for both sides.

The Do it Yourself Cockpit Project – Series One

Next, you want to mark the blocks 1-1/2” from the end closest to the windscreen lower face frame and again 2-3/4” from that mark. These are your center points for the next holes you need to drill.

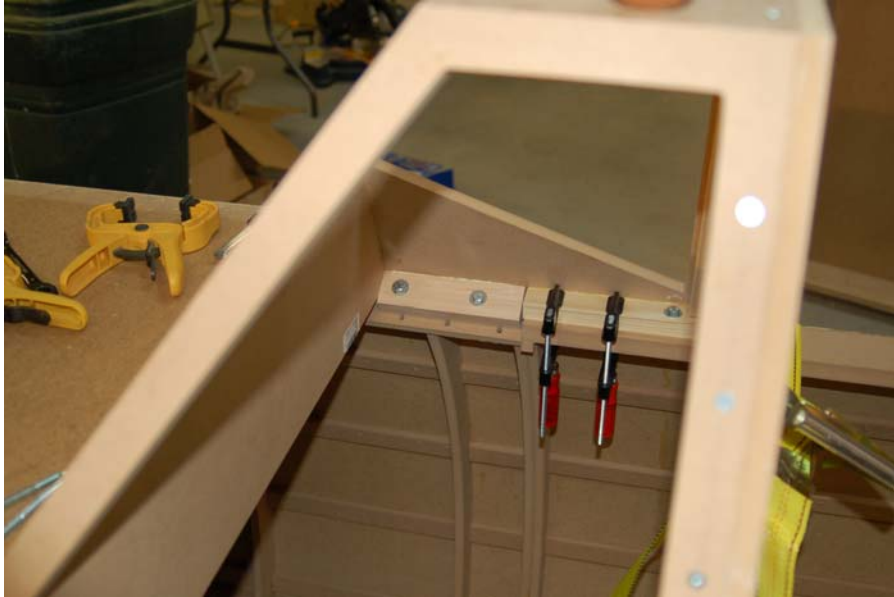

Install two 2” 1/4” hex head bolts on each side. If you had to compress or expand the cockpit sides more than 1/2” to make the windscreen assembly line up, leave everything as it is until the glue dries on all the windscreen & reinforcement blocks.

After everything has had time to dry, you can begin to remove your clamps. Start with the clamps on the inside of the windscreen and work your way out to the clamp or strap that you installed to align the cockpit sides with the windscreen.

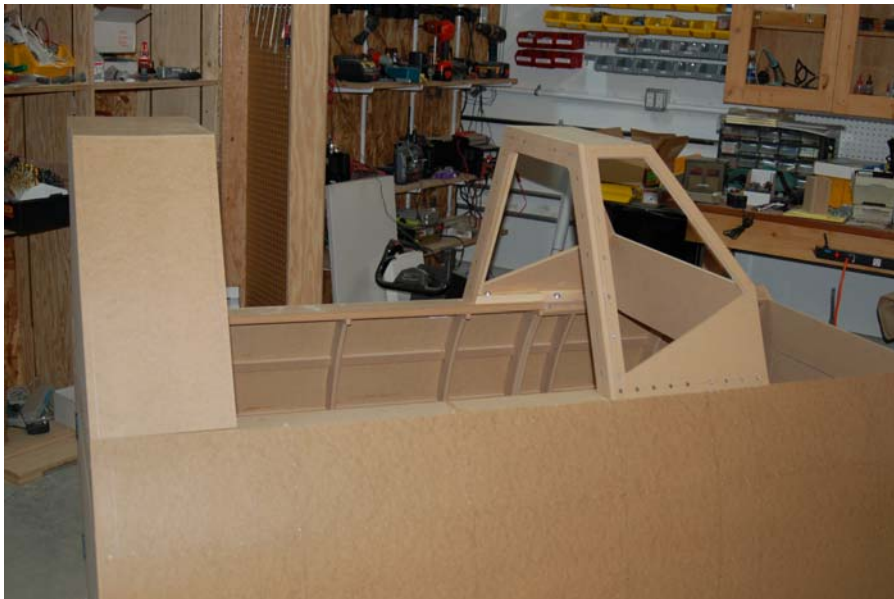

The Do it Yourself Cockpit Project – Series One

Congratulations! You're now done with the initial windscreen construction!

Now it's time to install the instrument panel support arches. In order to do that, you need to remove the windscreen from the cockpit. Just pull the bolts and take it off – you may notice that the side walls of the canopy may return to their original position before you installed the windscreen. This is normal and because you've got the mounting holes done, you won't have to go to the same trouble to re-install the windscreen assembly.

There are two different types of instrument panel support arches. One is the “low” arch that I'll be using here, and the other is a thinner profile, “high” arch. The mounting instructions for the arches are the same regardless of which you choose.

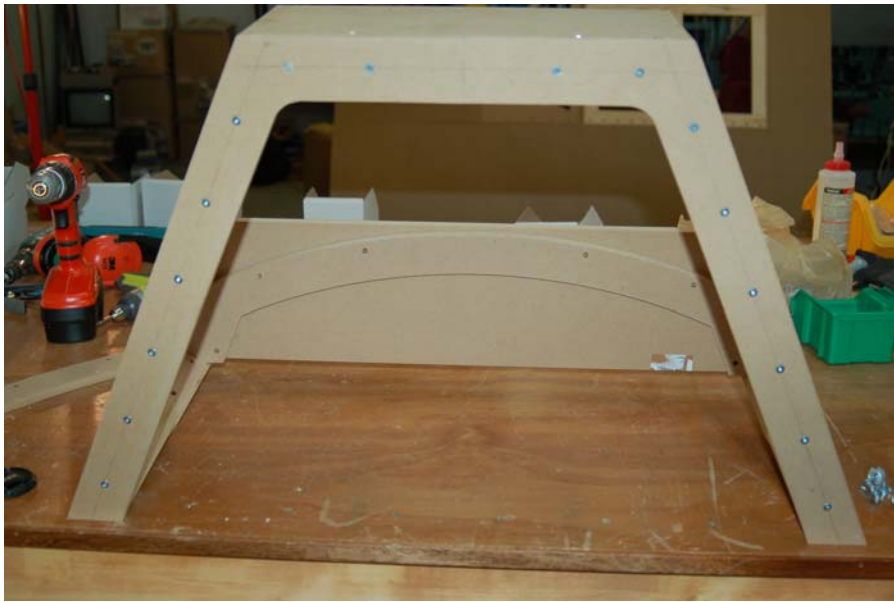

The first arch is installed flush against the lower face frame as shown above.

The Do it Yourself Cockpit Project – Series One

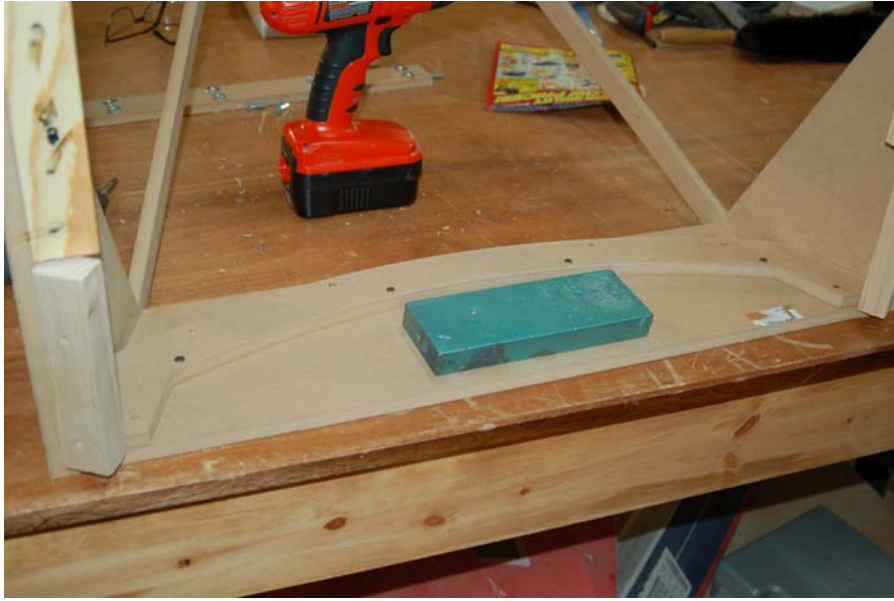

The arch can be attached with or without glue, your choice. If you glue it in however, you won't be able to change to a different instrument panel profile if you decide you want to. You'll have to build another windscreen frame.

The arch is attached with four $\frac{3}{4}$ " #8 flat head screws. Carefully drill $\frac{3}{4}$ " deep pilot holes and countersink them.



Take the matching arch and install 7 #10-24 t-nuts in the mounting holes.

The Do it Yourself Cockpit Project – Series One

To correctly mount the other instrument panel arch, you're going to need to cut four 4-3/8" spacers out of scrap 1x1/2" stringer stock as well as two spacer blocks of the same length made of 2x4. All six of these parts *must* be the same size! In order to make this easy, set your saw up similar to mine below:



What I've done here is set up a 2x4 as a stop-block that will allow me to cut 4-3/8" long parts until I run out of things to cut. Cut your four 1-1/2" spacers this way as well as the 2x4. When you're done, rip the 4-3/8" 2x4 in half. The 2x4 spacers will be used to correctly set the distance of the instrument panel arch at the base of the arch.



This is where the 2x4 spacers are placed.

The Do it Yourself Cockpit Project – Series One

Place the instrument panel arch into place:

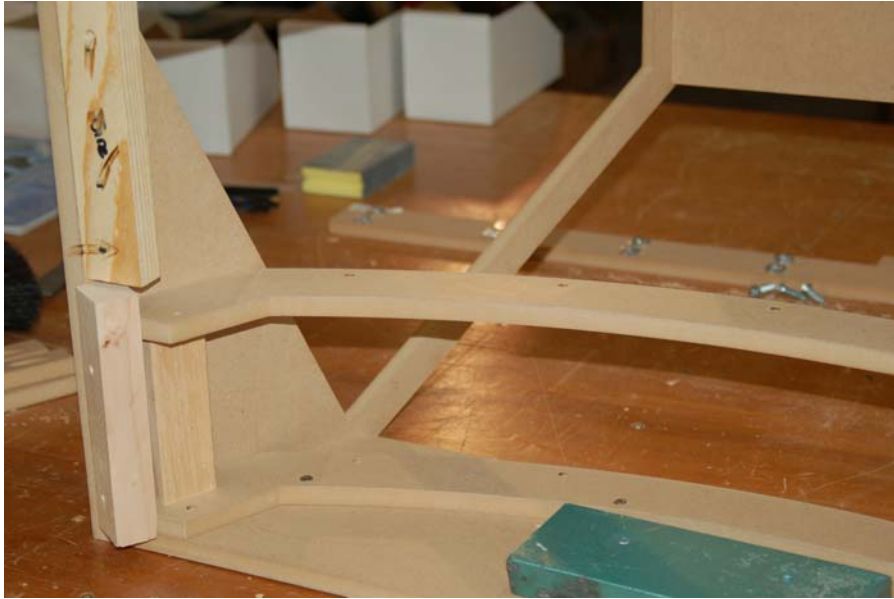

The panel arch is a very tight fit. You can tap it into place using a soft faced hammer, but please be careful. It will fit. Just have patience.

I'm going to rave about a new tool I just got my hands on – it's a pocket hole jig made by Kreg and it's insanely useful. You're lucky I didn't get my hands on this thing when I first started this project or you'd be up to your neck in pocket holes by now. I drilled out the four instrument panel arch spacers using this jig. It turned out to be the easiest method of mounting them without having to screw around with the pin nailer.

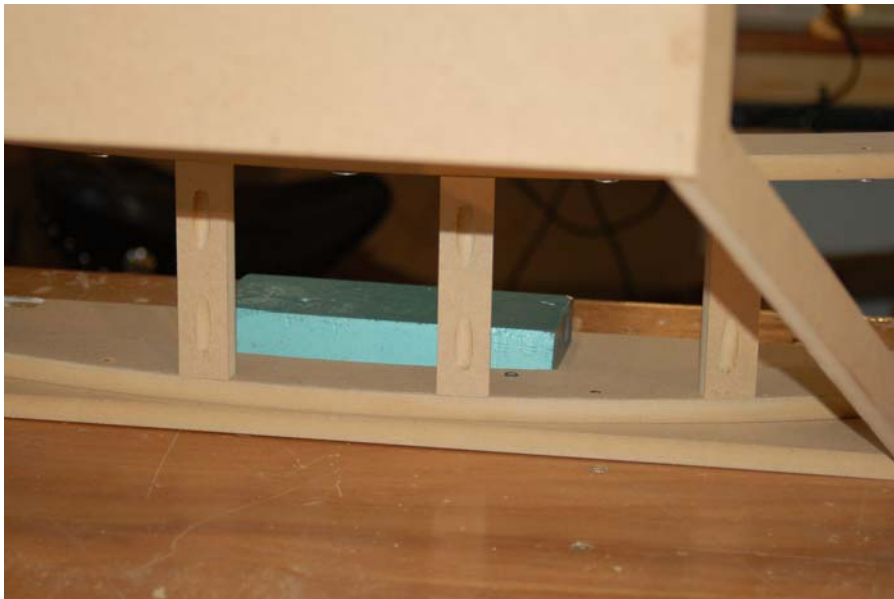

The Do it Yourself Cockpit Project – Series One

As you can see, the pocket holes are drilled in the top of the part. This allows you to screw it down and not interfere with the installation of the glare shield.

The picture below shows the first two spacers installed as well as the “beginner” model of Kreg pocket jig.



The spacers are installed between the middle 5 instrument panel mounting holes. Their exact position isn't cast in stone. As long as they're pretty much centered between the mounting holes and flush with the top of the instrument panel mounting arch, you'll be fine.



This is the jig that I used. \$99 for the kit, but well worth it.

The Do it Yourself Cockpit Project – Series One

When you've gotten all four spacers installed, they should look something like this:

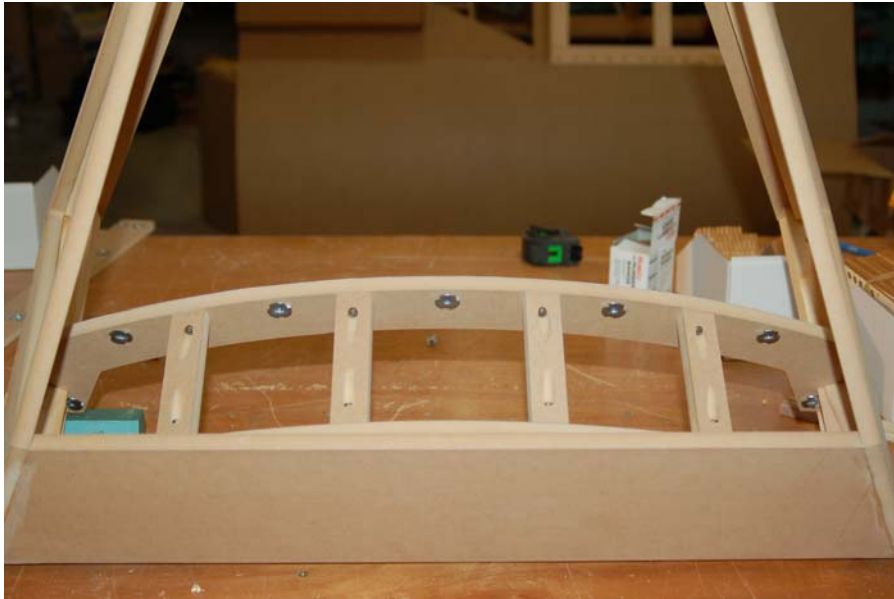

Do **NOT** remove the lower spacer blocks yet! You still need to secure the ends of the instrument panel arch.

Draw a line along the side of the windscreen frame that is centered on the panel arch you just installed:

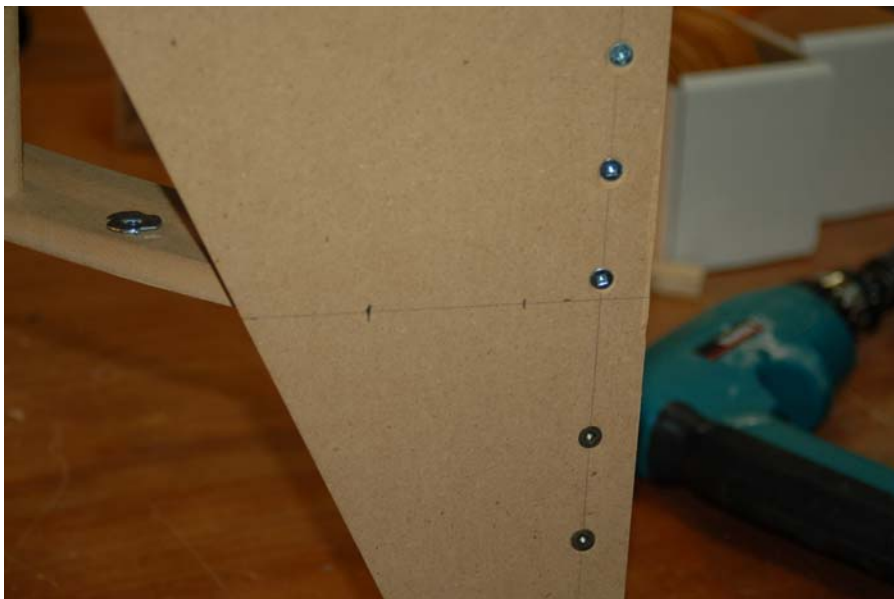

Draw a mark 1" from where the lines cross and then another 2" from that mark.

The Do it Yourself Cockpit Project – Series One

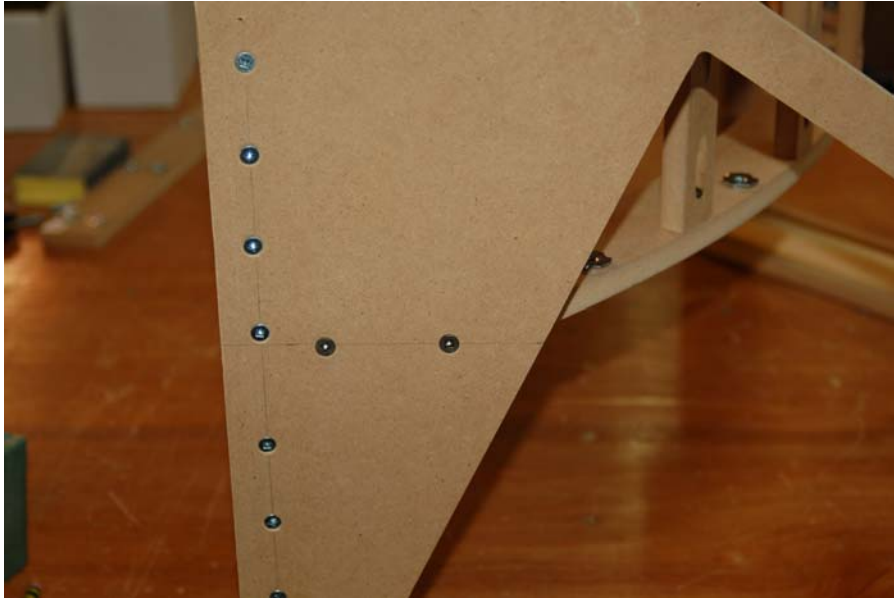

Drill 1" deep pilot holes and countersink. Install 2 1" #8 flat head screws on to each side. After you're done you can remove the spacer blocks.

Re-install the windscreen assembly into the cockpit. It should be fairly straightforward now that the mounting holes are drilled.

You need to temporarily install the instrument panel in order to complete the next few steps:



The panel needs to be installed in order for you to ensure that the instrument panel itself doesn't rise above the panel arch. If it does, the glare shield won't fit properly.

The Do it Yourself Cockpit Project – Series One

The panel can be sanded down to fit. If the differences are great enough, run a pencil along the top of the panel arch in order to draw a line on the back of the panel. This will give you a cutting/shaping guide to work from after you've removed the panel.

After the panel is correctly shaped, you need to see to the lower attachment points that are located in the side ribs. These holes are not present in the plan because there will be enough variance in how you build your cockpit that would render the hole locations incorrect.

Check out how much space you have between the panel face and the rib it will attach to:



The gap will be anywhere from nothing to about 3/8". Find a section of scrap material that will be suitable for a spacer. It needs to cover both of the holes that are in the instrument panel at this location.

The Do it Yourself Cockpit Project – Series One



When you've got your spacer in place (if you need one – I happen to need one for mine, but it's not shown here) clamp it down and drill an 11/64" hole (or a bit bigger) to accommodate a #10 bolt. When you're done, you can remove the instrument panel and set it aside. You won't be needing it until it's time for final assembly.

The glare shield is made from 1/8" hardboard. It's a single part about 25 1/2" long and 5 3/8" wide. I say "about" because construction differences between what you do and what I do can render that length figure a close ballpark number. I would suggest that you find a "fabric ruler" and measure the distance across the arc of the instrument panel mounting arch in order to ensure you get the correct length.

The Do it Yourself Cockpit Project – Series One

After you've cut the glare shield, test fit it to make sure it's snug at the ends and doesn't overhang the instrument panel support:



In order to attach the glare shield to the support stringers, you're going to need to draw a set of center lines on the instrument panel support that indicate the centerline of the stringers:

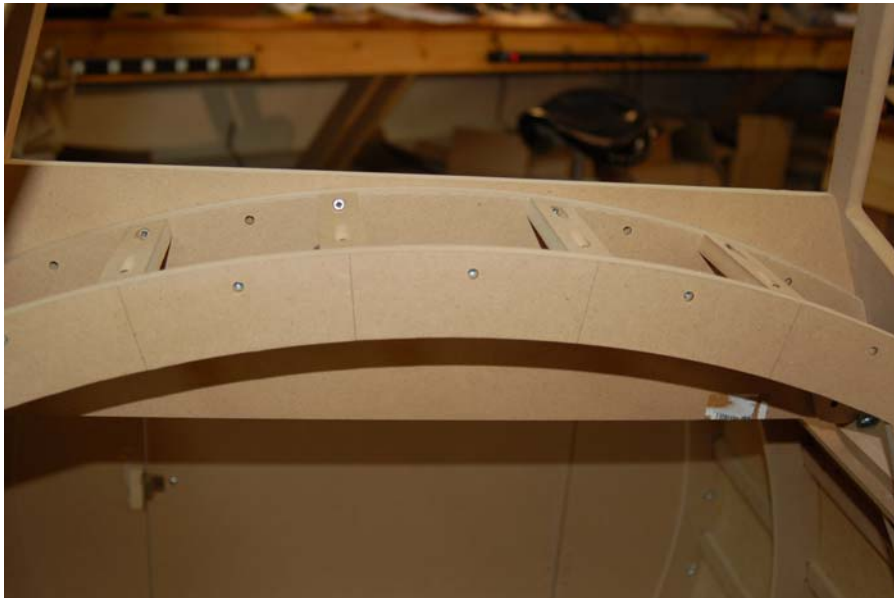

The Do it Yourself Cockpit Project – Series One

After marking the centers, install the glare shield so you can mark it:



You'll want to clamp the ends so that it doesn't shift while you are drawing the center lines and drilling for the mounting screws.

Draw lines along the short axis of the glare shield and a center mark at the half-way point (2.6875"):



Drill and countersink the center marks for #8 screws.

The Do it Yourself Cockpit Project – Series One

Use four $\frac{3}{4}$ " #8 screws to attach the glare shield to the windscreen.



Do NOT glue down the glare shield! If you do, you won't be able to reach the windscreen attachment bolts that are hidden by the glare shield!

That concludes this chapter! You're done with the windscreen and it's time to go have a beer and tell lies to your friends about how many bad guys you killed today. :)

The Do it Yourself Cockpit Project – Series One

The Do it Yourself Cockpit Project – Series One
Chapter Fifteen – Building the Canopy

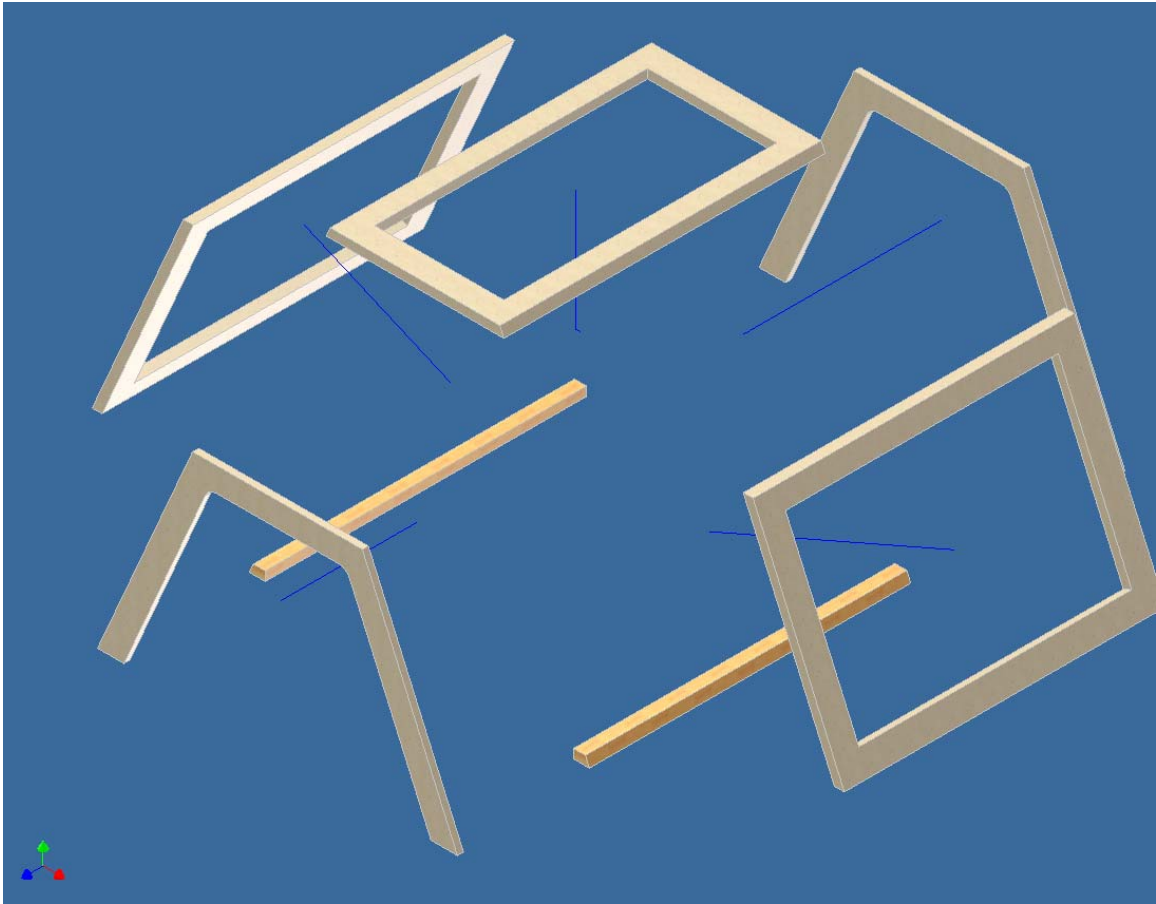

The Do it Yourself Cockpit Project – Series One

The canopy side frames and top frame can be built two different ways. In the prototype canopy, I ripped down 2” wide strips $\frac{3}{4}$ ” thick Pine and created the frames the way you’d see it done for a cabinet face. To make things simpler, I decided to use a single-piece design for the “production” version.

To create the side frames, you’ll need to cut two blanks from $\frac{3}{4}$ ” plywood or MDF. The frame dimensions are 26-1/2” by 19-5/32”. The top frame blank is 26-1/2” x 14-21/32”. Set up your combination square to a 2” depth and use it to draw a line 2” away from the four edges of the blanks. Cut this out. This will give you a 2” wide canopy frame. I don’t recommend less than 1-3/4” width on the framing. If it’s narrower than that, you may have problems drilling the pocket holes that are used to fasten the sides and top to the canopy end frames.

In order to assemble the canopy frame, you’ll need to first bevel the canopy frame parts at a 23.5 degree angle. The two side frames are cut at parallel angles and the top frame is cut on opposite angles.

You need to set your saw up to cut off only the angled portion – you don’t want to reduce the size of the frame itself or it won’t go together correctly. Review the windscreen chapter for details on correctly cutting angles off the end of parts.

The angles for the side frames are cut parallel to one another, like this “/ /”.

Before cutting the first angle, you should attach a flat board to your fence to ensure that when you cut the second angle, the material cannot slide under the fence and ruin the cut. (This will be shown on the next page)



This is your first cut. As you can see, my frame has been pocketed to allow me to add Plexiglas windows to it after it’s been finished.

The Do it Yourself Cockpit Project – Series One

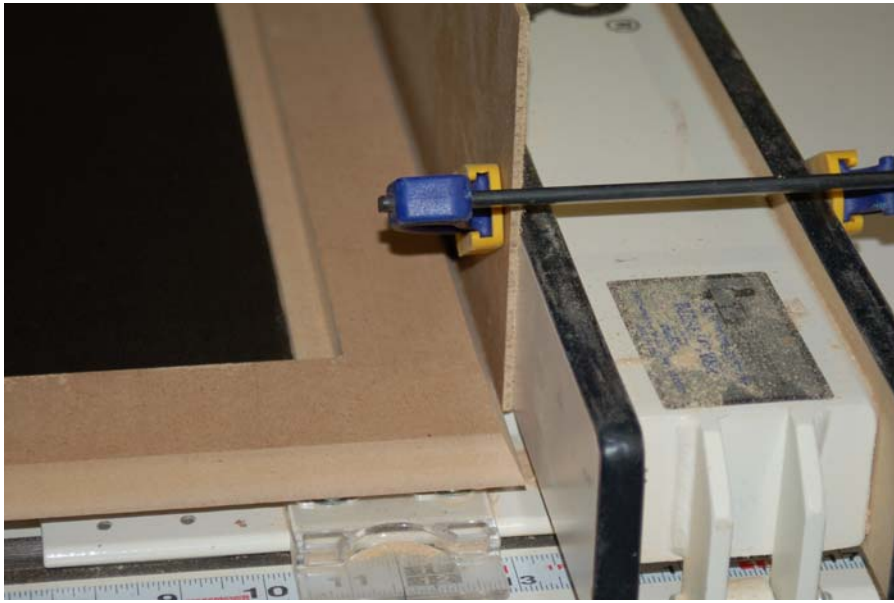

You can see from this picture why the additional material on the fence is required. If it wasn't there, the thin edge of the angled cut would slide under the fence about 1/8" (may vary on your saw) and would ruin the opposite cut.

The top frame is cut with its angles facing one another, like this “/ \”. When cut, the part should look like this:

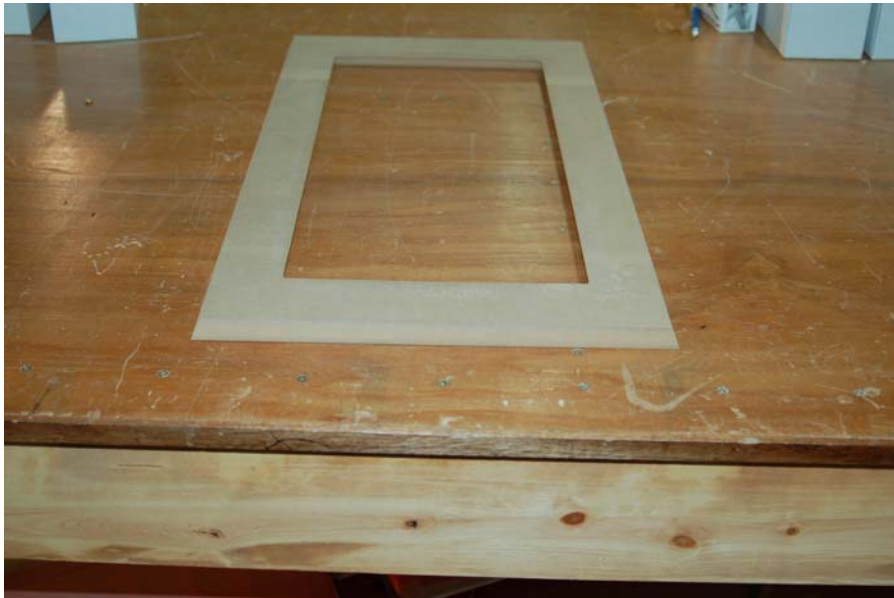

Note that if you've routed out an area to hold a Plexiglas window, you want to make sure that your angle cuts are made on the opposite side from that. The routed area should be on the side of the panel where the base of the angles are farthest apart from one another.

The Do it Yourself Cockpit Project – Series One

The last parts you'll need to make are the two canopy base stringers. These are made from pine (You could use any 3/4" thick material here) and are 3/4" x 1", 26 1/2" long and have a 23.5 degree cut along the width. These parts are shown below:



I recommend using Pine as it needs to take screws and MDF doesn't perform well with screws entering in the "end grain".

The Do it Yourself Cockpit Project – Series One

In order to assemble the canopy frames, I strongly suggest using a Kreg Pocket Jig. They're only \$20 and are a fantastic addition to your toolbox.

The pocket holes in the canopy side frames are only drilled along the top edge and along both ends. The bottom edge must not be drilled!

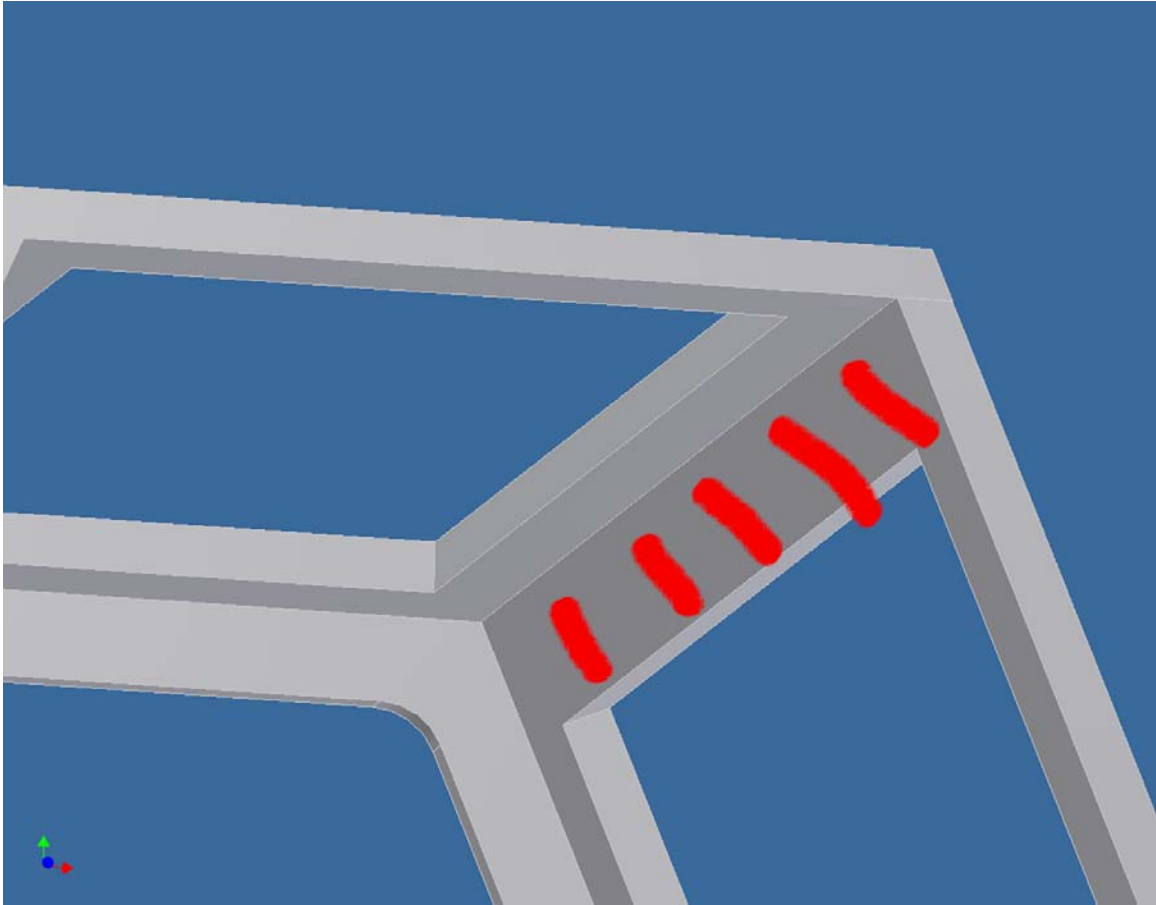

It's obvious I'm no artist, but you need to make sure that you drill the pocket holes as shown above.

Each frame needs 5 pocket holes drilled. One at each end, 1" in from the edge, one at 6-5/8" from each end (2 holes) and a 5th at the 13 1/4" point.

Setting up the Kreg jig for drilling the holes is very simple and can be seen on the next page.

The Do it Yourself Cockpit Project – Series One



Just clamp the jig down and have at. Because of the angle cut, you're not going to use 1 ¼" screws as recommended by Kreg. They're just a tiny bit too long (I found out the hard way) and you'll need to use 1" screws...

When you're finished, the top of the frame should look like this:



As you can see, the holes on my part are not exactly even on the ends. This was strictly my fault and yours should be 1" in from the ends. :)

The Do it Yourself Cockpit Project – Series One

Next, you need to drill five more pocket holes along the ends of the canopy sides:



From each end, drill holes at 2 ¼", 4 ¾" and a single one at 9 ½". These are the attachment points for the canopy arch frames.

Now you can begin to assemble the canopy frame:



The special clamps that Kreg sells really makes this kind of assembly easier. Don't forget to apply glue along the top of the side frame before you clamp it up. Install 5 1" pocket screws. Be careful to ensure that the angle on the top frame is flush with the outside surface of the canopy side frame.

The Do it Yourself Cockpit Project – Series One

Take special care when putting the screws in – if the frames are not clamped firmly, they can slide around a bit because the glue acts like a lubricant.

Assemble both sides:



Make sure you wipe away any excess glue that has been squeezed from the seams.

Now you can start to install the canopy end frames:



These go on very easily, just make sure you apply glue to the ends of the framework before you attach the canopy ends.

The Do it Yourself Cockpit Project – Series One

At this point the canopy should look like this:



The next step is to install the two 26-1/2" Pine stringers. You need to draw a base line that is offset 5/8" from the bottom edge of the side frame:



The line is a bit difficult to see, but it's there. Now measure in 1-1/4" from each end and make a mark on the base line. Again from the end, measure in 3-7/16" and make a mark. From that mark, measure another 3-7/16" and make a mark. Repeat that for another 5 points. You should end up with 2 marks at 1-1/4" in from the ends, and 7 marks spaced 3-7/16" apart as shown in the picture on the next page.

The Do it Yourself Cockpit Project – Series One



At each one of the marks, drill a $\frac{7}{64}$ " pilot hole $1\frac{1}{4}$ " deep. Make sure that you keep the drill bit as perpendicular as possible with the frame face. Countersink each hole and insert a $1\frac{1}{4}$ " #8 flat head screw:



If you're not careful, you'll end up with an "uh-oh" as shown below.

If this happens to you, the end can be removed with a file or angle



The Do it Yourself Cockpit Project – Series One

When you're done, the canopy should look like this:



To finish off the canopy, you'll need to install flush dowel inserts into all of the pocket holes as shown:

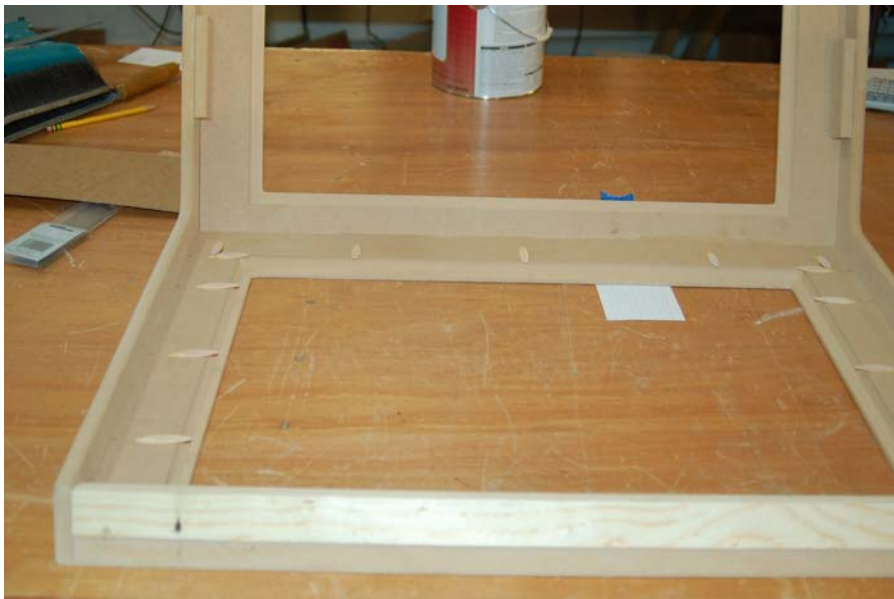

I used pre-made plugs from Kreg. They were part number “P-NT”, Paint Grade Plugs. They're about \$5 for a box of 50. Each one should have a little glue applied and then be pressed into the pocket hole. Let the glue dry and then you can start hating me....

The Do it Yourself Cockpit Project – Series One

Why you ask? Well now you have to trim all of those nice pocket hole plugs to be even with the canopy frame surface. There are two ways to do this. The easy way, and the way I ended up having to do it.

If you're going to do it the Easy Way(TM), you'll need to get one of those fancy Dremel flush cut saws. This makes very short work of the hole plugs and leaves you with a nice flush cut.

If you're going to do it MY way, you'll need a hand powered flush cut saw that looks something like this:



The amount of time it takes is directly proportionate to the amount of time you can run the saw in-between your hands cramping up. :)

In the end either way, you'll have a pile of little cut off bits:



After you've got them all cut flush, sand them down to take any grooves out and then apply wood filler to each one to fill in any remaining space. You should also fill in any gaps, grooves or brad holes that you find anywhere on the canopy frame.

The Do it Yourself Cockpit Project – Series One



This is the assembled canopy. Congratulations! You're done building stuff!

Take a break, grab your beverage of choice and relax for a while. The next chapter will cover final assembly and some exterior finishing tips.

I should note that the weekend after I did the canopy build, Rob showed up with one of those fancy Dremel flush cut saws. I used a lot of bad words. :)

The Do it Yourself Cockpit Project – Series One

The Do it Yourself Cockpit Project – Series One
Chapter Sixteen – Final Assembly & Finishing Tips

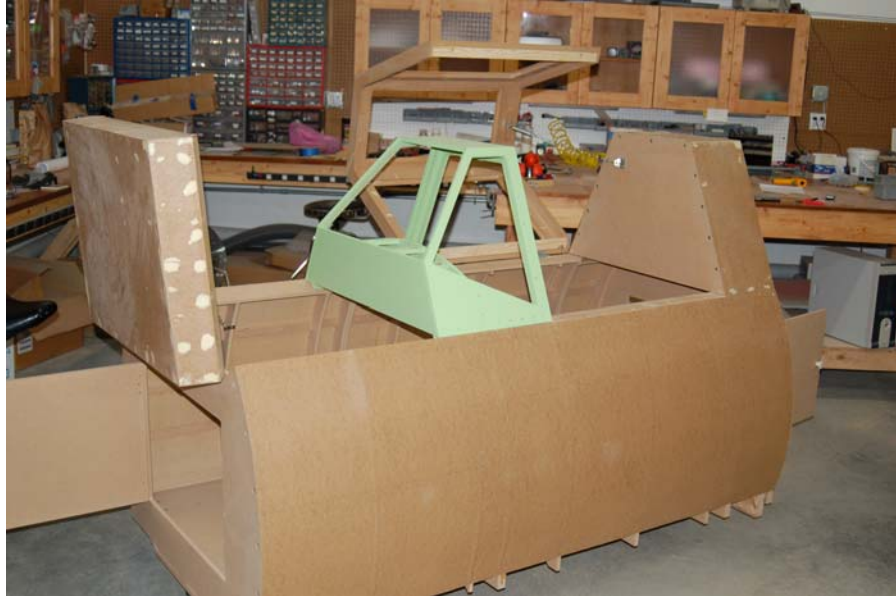

The Do it Yourself Cockpit Project – Series One

Needed Materials

Qty	Description
2	1" L brackets
8	½", #8 pan head screws (for installing the L brackets)
1	Spring & Chain screen door retainer
1	26" long lightweight chain

Congratulations, you made it this far! Now it's time to install all of those nice canopy and windscreen parts you just built!

Go ahead and get the cockpit assembled up to and including the windscreen assembly as shown in prior chapters. This chapter will only cover components that have not yet been installed.

The first part to be installed is going to be the Monitor Deck. Because the floor in my shop was poured by a completely incompetent fool (not me this time!), there isn't a level spot the size of the cockpit anywhere. The result of this is that after a couple of weeks the cockpit twisted a bit, requiring me to take drastic measures in order to "re-true" the cockpit:



It looks pretty extreme, but it does work. A few days after I did this, I loosened everything up and set it up on a pair of leveled saw horses. After a day or so of "resting" I re-tightened everything up and it was okay. Just something to be aware of.

The Monitor Deck is installed with a pair of 2-1/2" hinges that have removable pins. If you don't want to use hinges with removable pins, I strongly suggest you do your finish paint work before installing the Monitor Deck.

The Do it Yourself Cockpit Project – Series One

In order to properly install the hinges, it's easiest to use a centering pilot drill designed for the task:

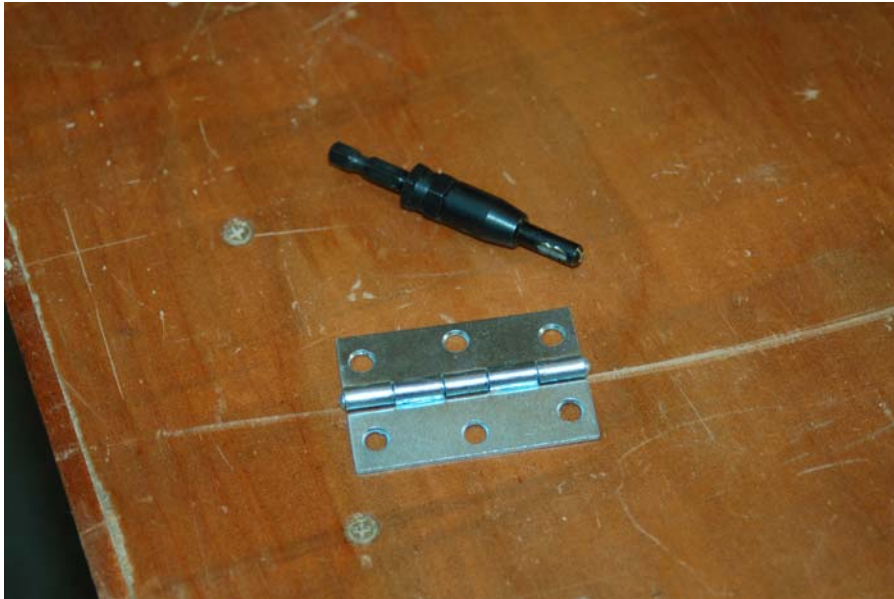

Using this special pilot drill, the hole will be exactly centered in the mounting hole of the hinge as you drill. Works great!



Placement of the hinges doesn't need to be exact as I've shown. Note that you won't have the top row of 1/4" holes in yours. They're in mine because I had to create parts that would work for both versions for this construction manual.

The Do it Yourself Cockpit Project – Series One

Now it's time to get the canopy installed.



Set the canopy in place as shown above. The canopy hinges are installed on the “right” side of the cockpit as you face forward along the cockpit, just like you'd see in any similar WWII vintage fighter of that style.

You need to align the canopy along the right edge so it looks like this:



As you can see, the edge of the canopy frame is on the *inside* of the skin surface. You may notice that the canopy doesn't appear to fit properly. This isn't a design flaw per-se, but a side effect of building with wood while measuring with metal tolerances.

The Do it Yourself Cockpit Project – Series One

Despite the appearance, you need to ensure that the right edge is as shown above or the hinge installation won't work properly.

In order to install the hinges, you're going to need to “pocket” a space for the hinge leaves in both the canopy frame and the cockpit railing. You want to set the depth of the pocket to be as close to the thickness of the hinge leaf as you can.



The picture above shows the spacing of the leaves approximately how they would be when the canopy is closed. You want to measure this width – outside to outside and half of that distance will be the pocket depth you'll be cutting out.



In order to properly make the pockets for the hinges, you'll need to mark where the hinges go on both the canopy and the cockpit as shown above.

The Do it Yourself Cockpit Project – Series One

Mark the hinge location approximately where you see it in the photo on the previous page. You want the hinge to be about 3” in from the canopy ends, but the location isn't critical.

Now remove the canopy from the cockpit and using a speed square or a combination square, draw two lines across the cockpit rail where you drew your initial marks in the previous step:



Draw lines on the bottom of the canopy framing as well:



The Do it Yourself Cockpit Project – Series One

Next, you'll measure in about $\frac{3}{4}$ " or the width of a hinge leaf if your hinges are larger than the ones I use:



Both the cockpit and canopy need these marks on all four hinge pocket locations:



Now you need to get your router set up for the correct depth so you can make the hinge pockets. This can also be done with a sharp, $\frac{3}{4}$ " wide wood chisel.

The Do it Yourself Cockpit Project – Series One

You need to be very careful if you use a router to make the hinge pockets. The area you're working in is small and it can be hard to see. This make mistakes easy to make.



As you can see in the picture above, mistakes do happen. Nothing that can't be hidden with a little wood putty though.

Using either a corner chisel or a 1/2" wide wood chisel, clean up the pocket to give it sharp interior corners and test fit the hinge to make sure that it fits snugly and all the way down into the pocket.



The Do it Yourself Cockpit Project – Series One

The hinge pin area needs to be routed out a bit in order to allow the hinge pin to be extracted so the canopy can be removed later. I strongly recommend that you make new hinge pins that are “L” shaped in order to make extracting the pins a lot easier. As you can see in the picture on the previous page, my hinge pin is just a little bent. This happened while extracting it the first time. The hinges that your local “home centers” sell aren't the highest quality and have soft metal hinge pins that are easy to bend.

Now it's time to make the pockets on the canopy side:



The pocket is cut the same as the previous ones. Be careful and take your time!

Using the self-centering pilot drill, install the two hinges into the canopy frame. Make sure that you don't drill the holes too deeply, or you'll poke through the outside face of the canopy frame. You only have about $\frac{3}{4}$ " to work with so take care.

The Do it Yourself Cockpit Project – Series One



For the final installation, set the canopy in place as shown above with a chair or a friend holding the canopy in place while you get everything aligned. When you're sure it's good, drill your pilot holes and finish the hinge installation.



It's not hard to get this done right the first time, especially if you take your time.

The Do it Yourself Cockpit Project – Series One

This is how the finished installation should appear:



Now you need to install the canopy retaining system. This is just a spring & chain that you can find at your local hardware store. They're used most commonly to prevent screen doors from being opened too far. It serves the same purpose here.

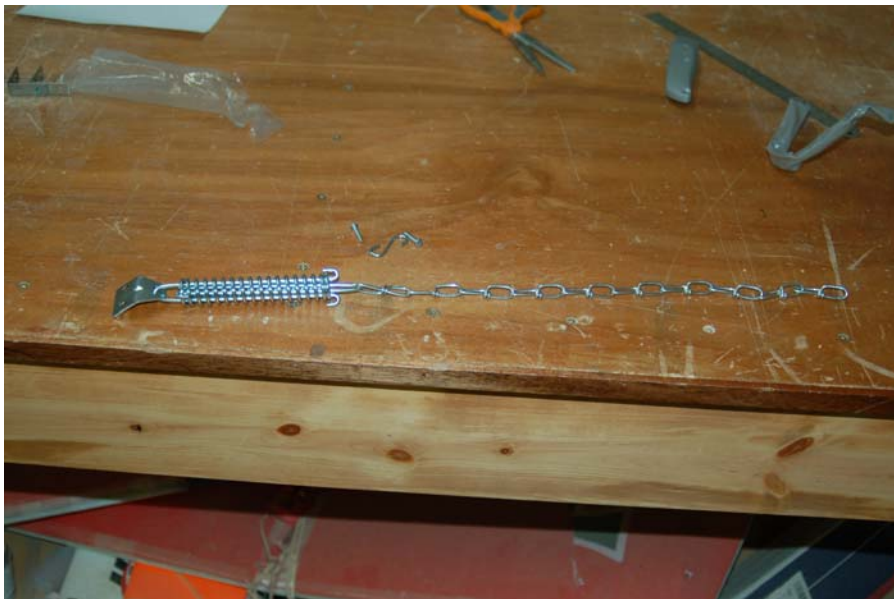

The Do it Yourself Cockpit Project – Series One

Close the canopy and draw a line that traces the inside corner of the canopy as shown below:



This line is the “do not cross” border that will dictate where you can safely install the chain end of the canopy retainer.

Position the mounting clip about 1-1/2” to 2” away from the side line and about an inch below the top line as shown:



You'll want to use your self-centering pilot drill here as well, just to make sure an offset screw hole doesn't shove the clip out of position.

The Do it Yourself Cockpit Project – Series One

Now you need to mount the other end of the canopy retainer on the inside of the canopy frame. The retaining clip should be located in the middle of the rear frame as shown:

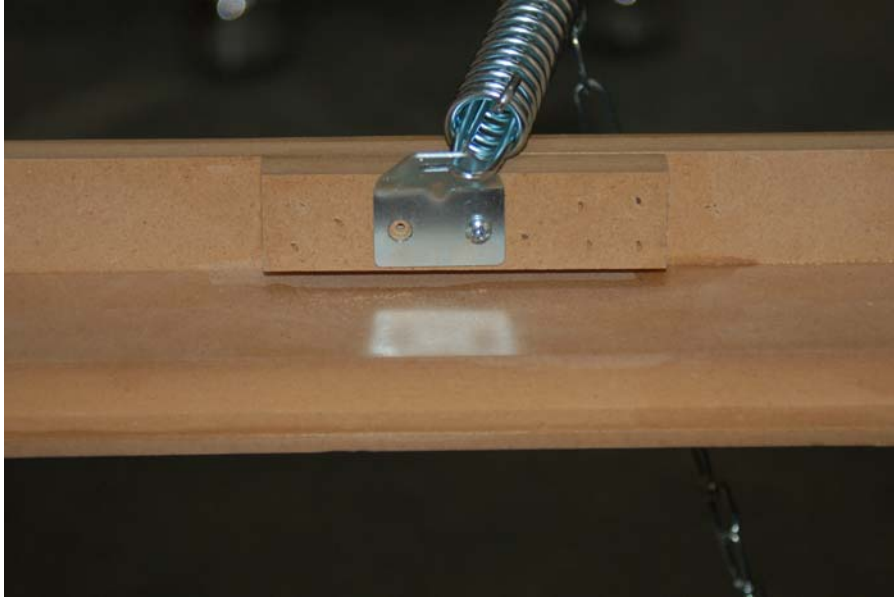

It's missing the screw for illustrative purposes. :)



The Do it Yourself Cockpit Project – Series One

When you're done, attach the supplied "S" hook to the cockpit mounted retaining clip and you're done!

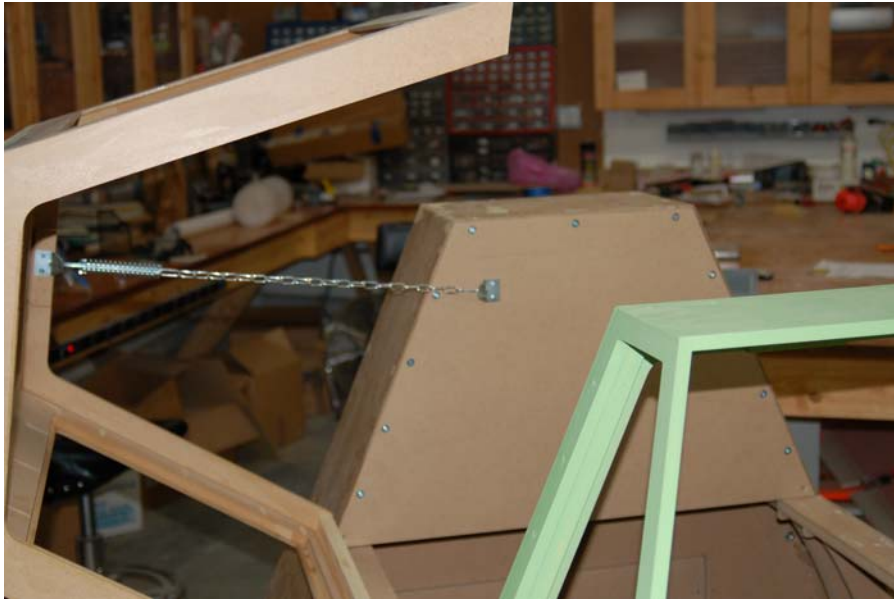

The spring will prevent the canopy from experiencing any sharp shocks from being opened too far.



The Do it Yourself Cockpit Project – Series One

All you have left to do is install the retaining chain to the Monitor Deck.

Install an “L” bracket in the area shown below on the Monitor Deck:



It's a tight fit, so you may not be able to drill pilot holes. Do so if you can. It makes installation a lot easier.

Mount the other “L” bracket towards the upper end of the second fuselage rib on the left side as you're facing the cockpit:

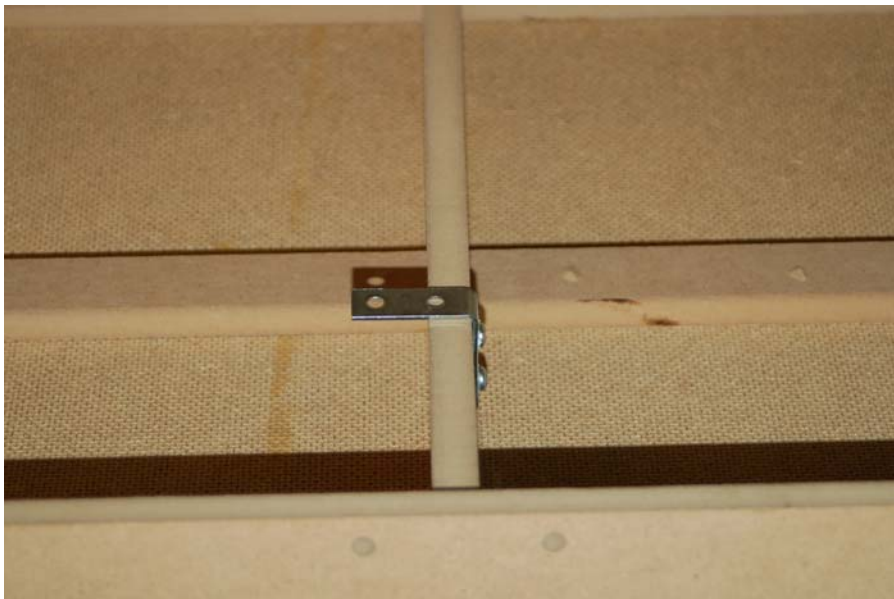

You have a little more room here for drilling pilot holes...

The Do it Yourself Cockpit Project – Series One

Here's a photo that shows where the “L” brackets go just in case I wasn't clear:



Now take your 26” length of chain, add the “S” hooks to the ends and install:



That's it! You're done with the construction of the Series One DIY Cockpit!

When you're ready to paint your cockpit, don't forget to use a good sanding sealer first. By painting all the wood surfaces with a couple of coats of sanding sealer, you'll ensure that you get a good, even coat of paint. Without it, the wood and especially the MDF will soak up the paint like a sponge. This will leave you with a splotchy looking paint job.

The Do it Yourself Cockpit Project – Series One

You may notice that the windscreen in recent pictures is kind of a green color. This is just a regular flat primer that I had tinted Zinc Chromate Green. Zinc Chromate is an anti-corrosive paint that's used to powder coat aircraft parts. While real Zinc Chromate is too dangerous to mess with for a home cockpit, nothing says you can't fake it.

I had my paint color-matched to an old inspection panel from a Boeing 707 and the resulting color is spot on.

If you have a local Ace Hardware near you, the following information will allow them to mix the paint for you:

Exterior Latex Products
Royal Shield Flat (103)

Ingredient	Formula		
AXX	4	42	0
D	0	41	1
L	0	47	1

Neutral 170A340 Gallon

If you don't have an Ace Hardware near you, email me with your address and I can send you a color sample on a bit of 3x5 index card that your local hardware store should be able to sample.

The Do it Yourself Cockpit Project – Series One

The Do it Yourself Cockpit Project – Series One
Appendix A – Reference Drawings

The Do it Yourself Cockpit Project – Series One

Right Cockpit Side – Parts Arrangement

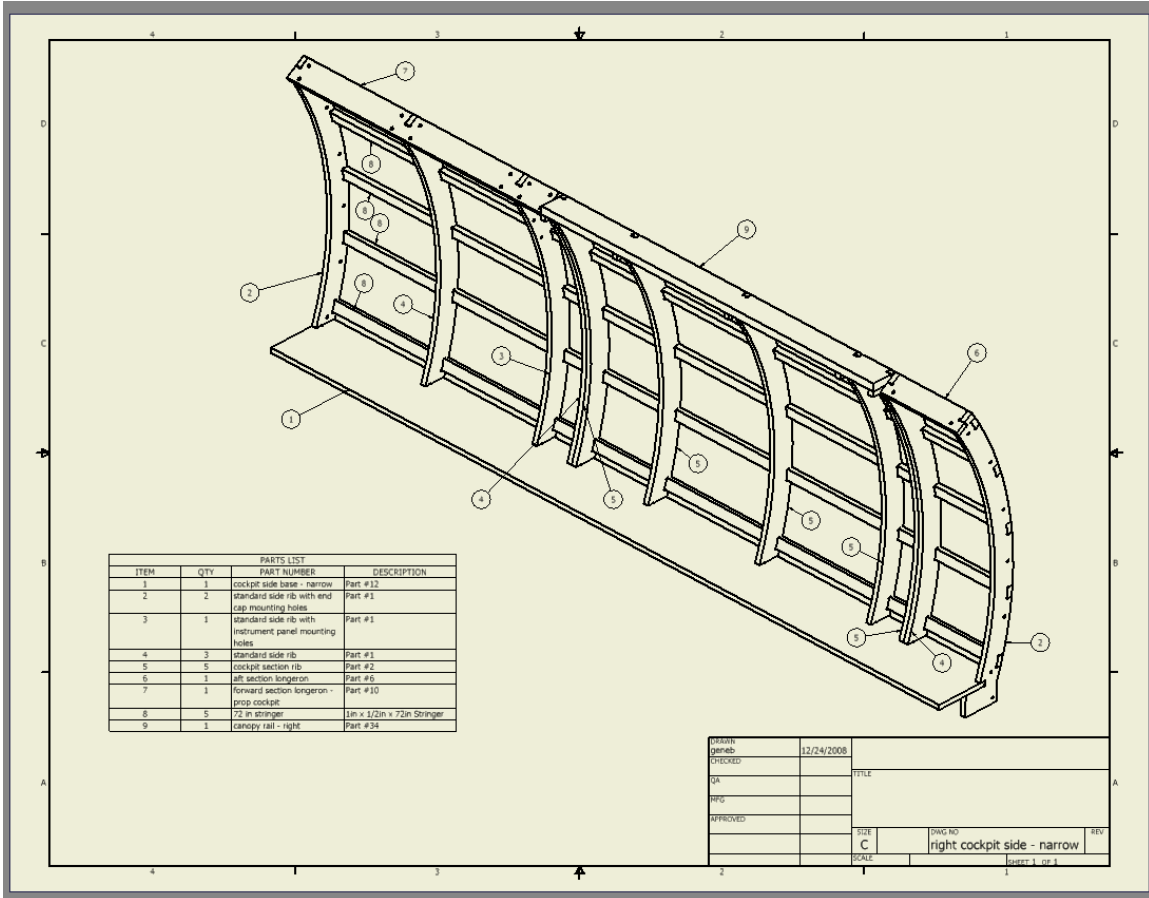

The Do it Yourself Cockpit Project – Series One

Left Cockpit Side – Parts Arrangement

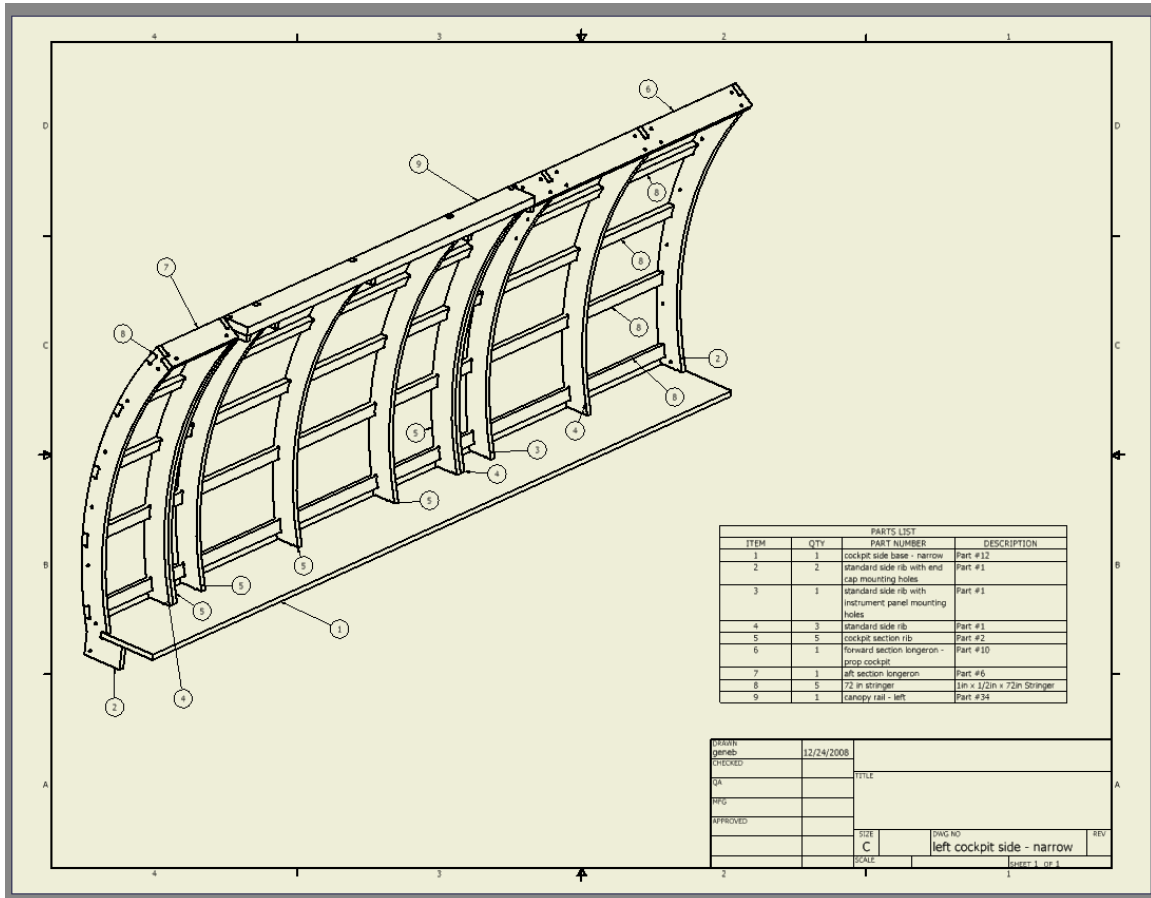

The Do it Yourself Cockpit Project – Series One

Forward Turtle Deck Parts Arrangement:

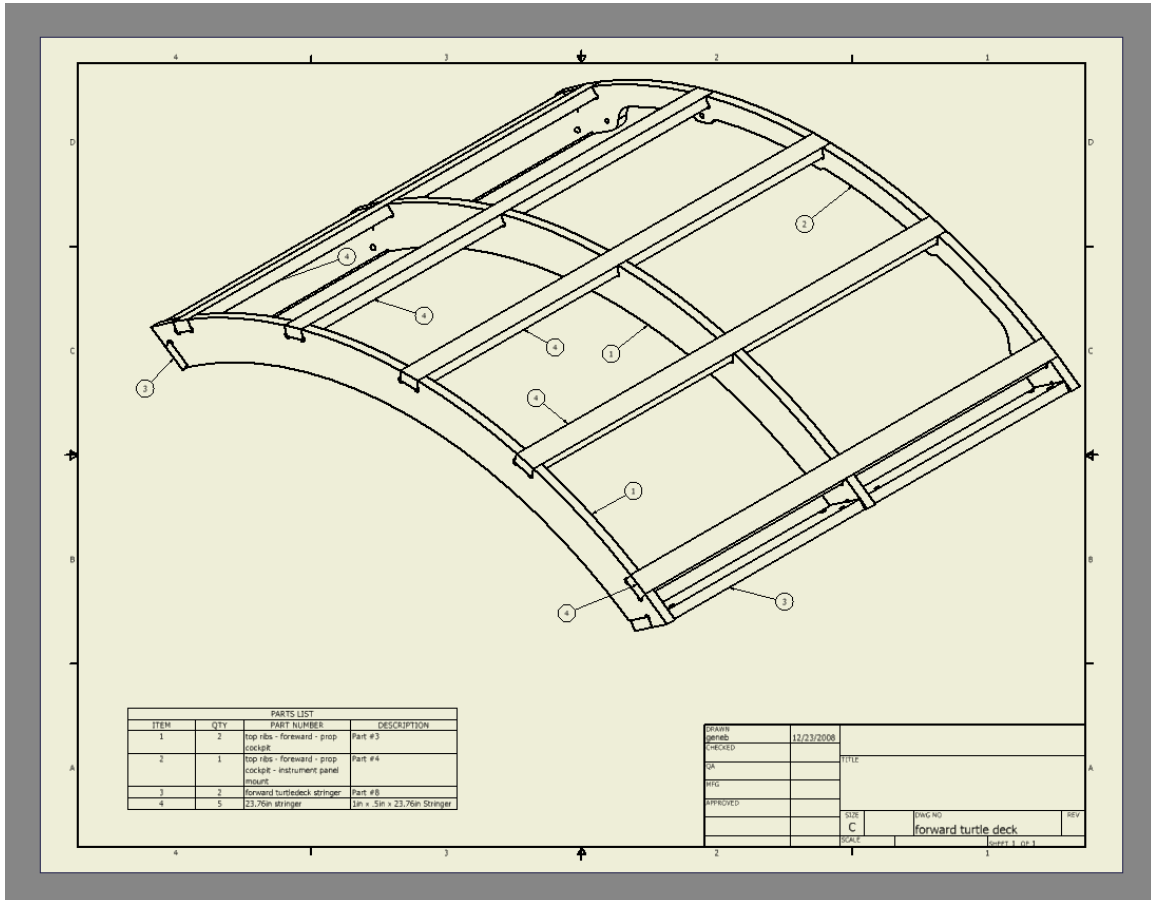

The Do it Yourself Cockpit Project – Series One

Instrument Panel Support Parts Arrangement

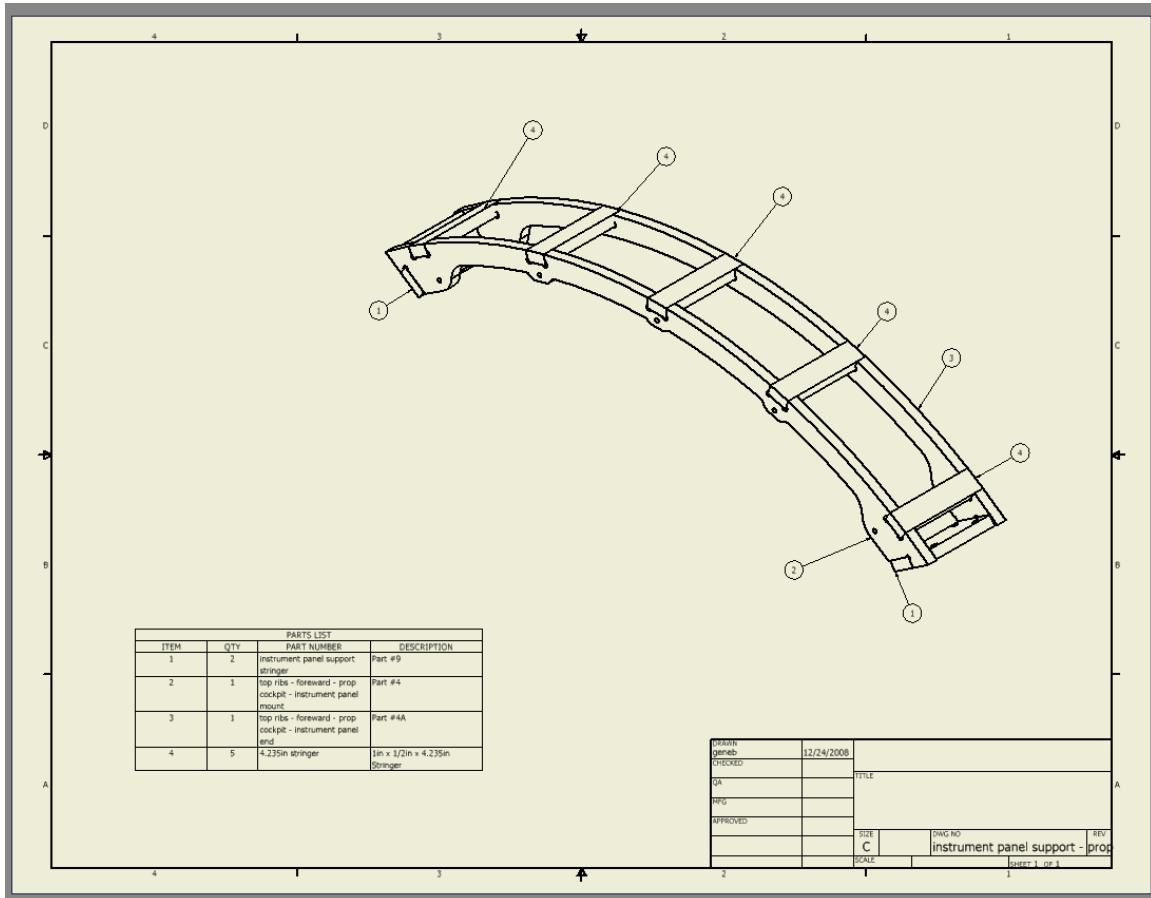

The Do it Yourself Cockpit Project – Series One

Aft Cockpit Arch – Parts Arrangement

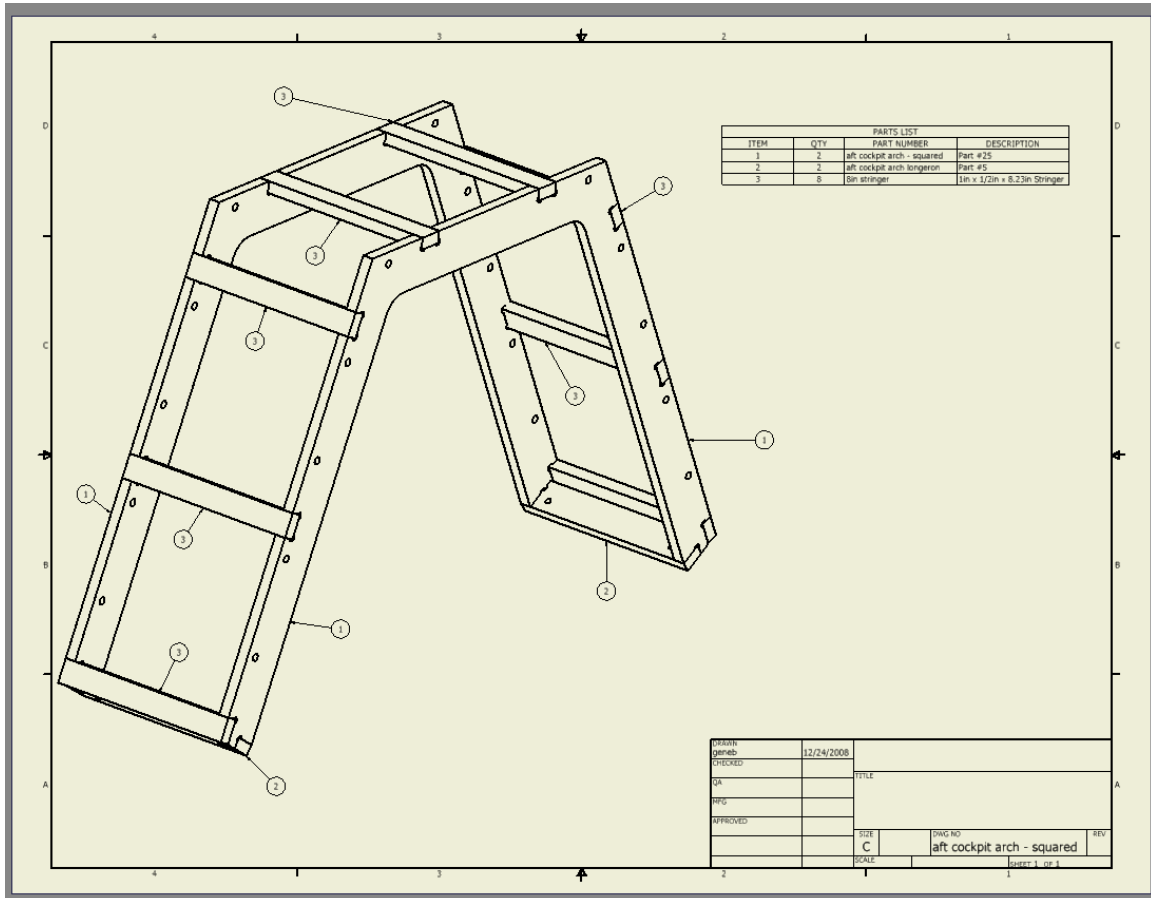

The Do it Yourself Cockpit Project – Series One

Aft End Cap Parts Arrangement

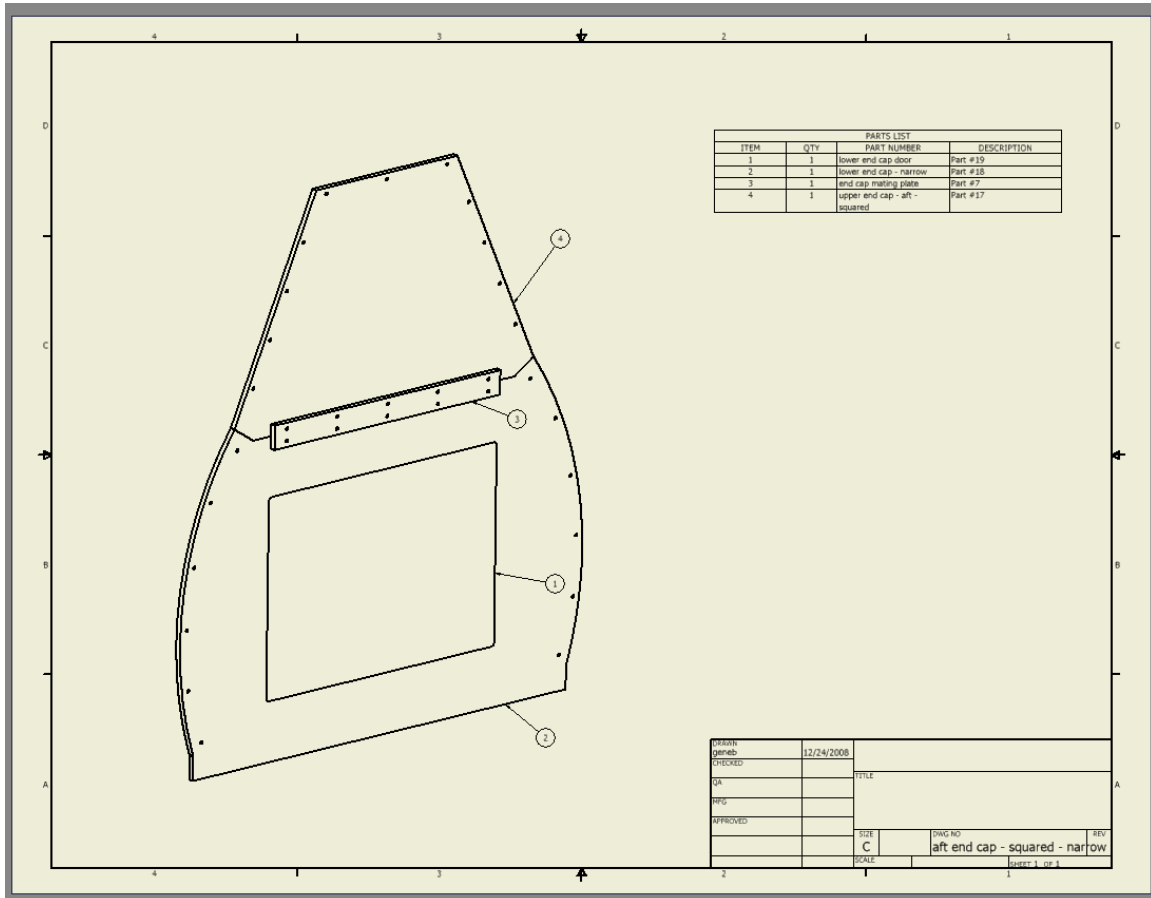

The Do it Yourself Cockpit Project – Series One

Windscreen – Parts Arrangement

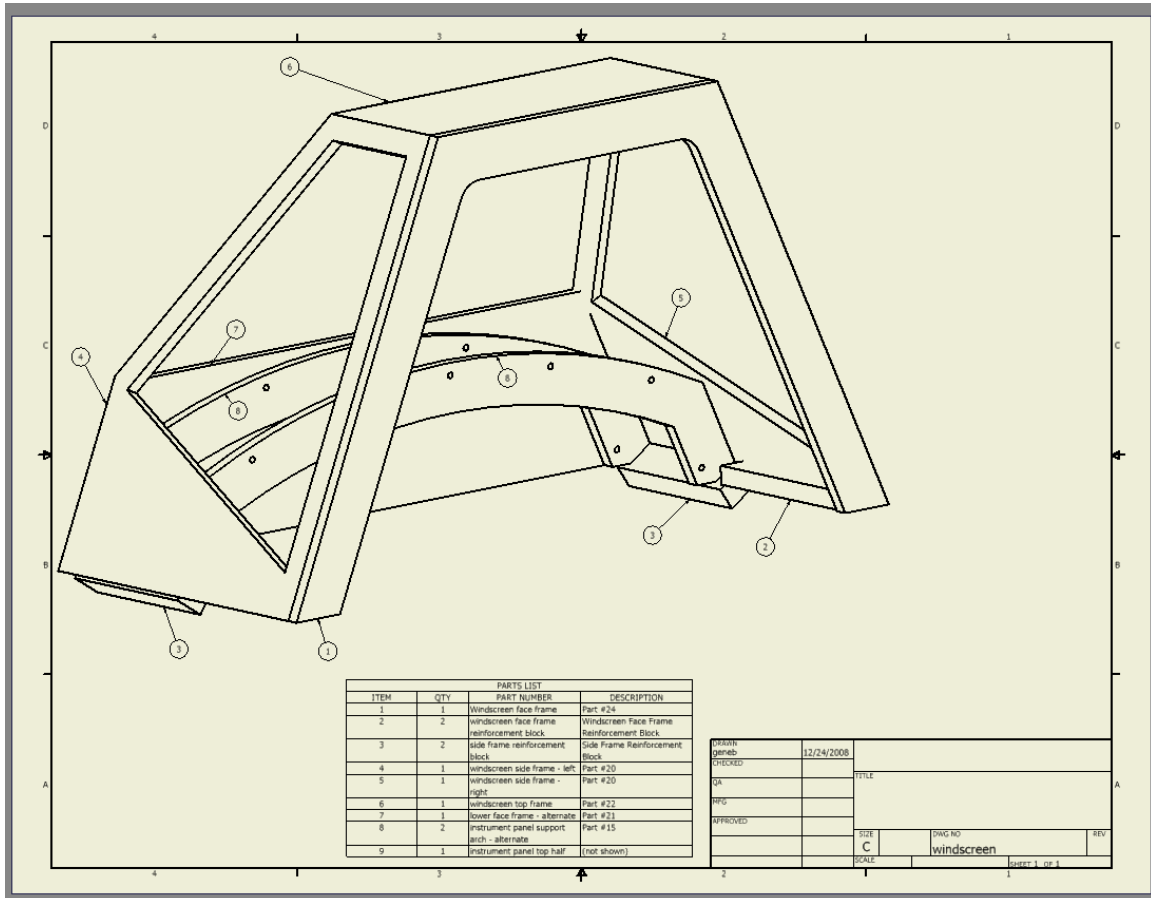

The Do it Yourself Cockpit Project – Series One

Monitor Deck – Parts Arrangement

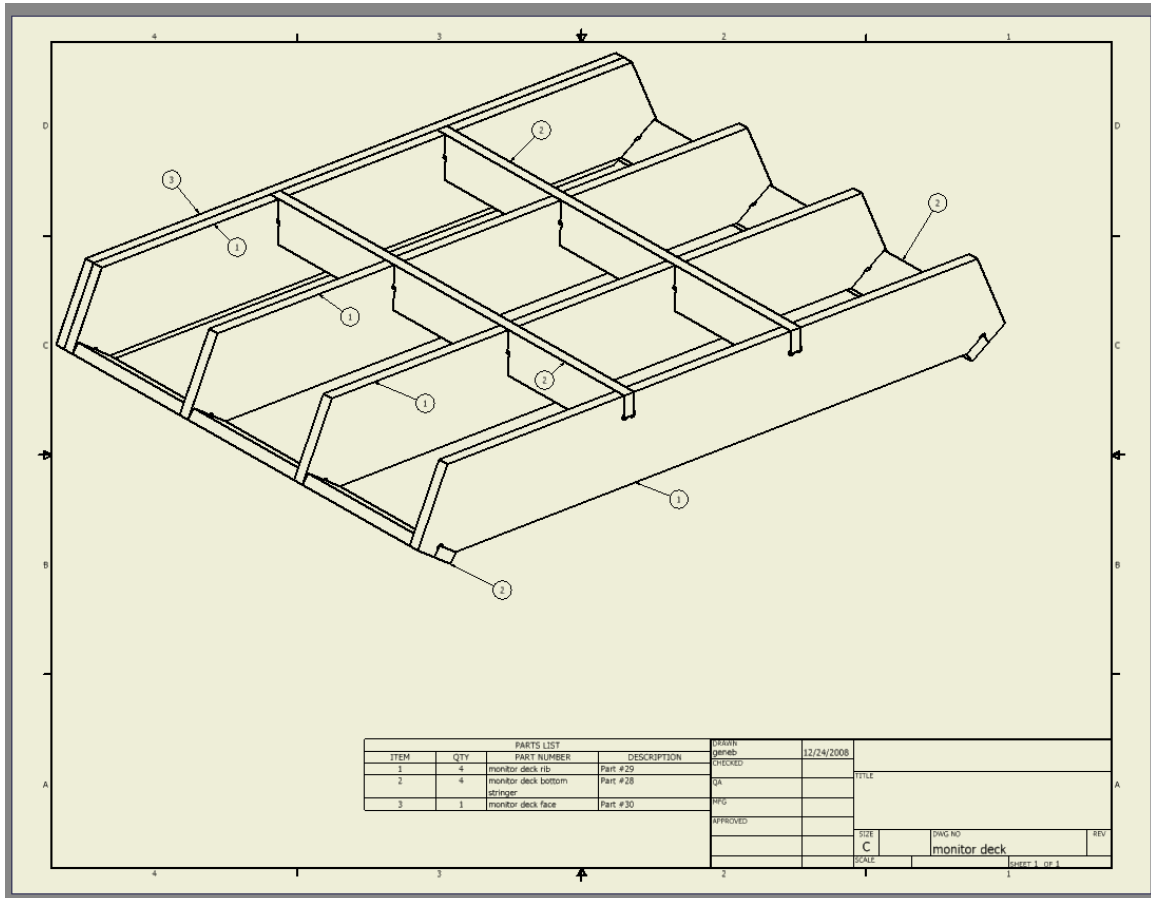

The Do it Yourself Cockpit Project – Series One

Canopy Frame Parts Arrangement

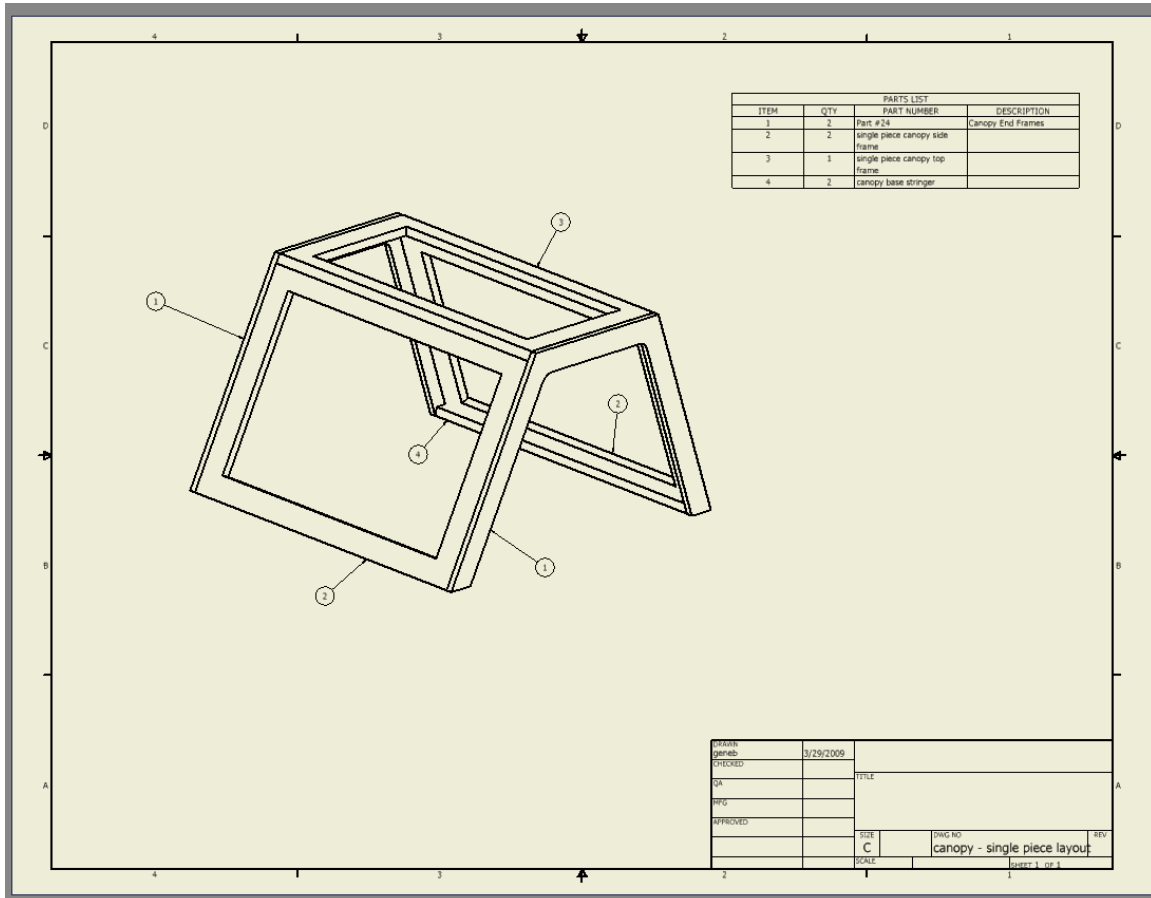

The Do it Yourself Cockpit Project – Series One